 <p>Adelaide Plains Council</p>	<p>21.1 Confidential Item</p>
<p>16 December 2019</p>	

21.1 Australia Day Awards 2020

RECOMMENDATION

“that:-

- 1. Pursuant to section 90(2) of the *Local Government Act 1999*, the Council orders that all members of the public, except Chief Executive Officer, General Manger – Governance and Executive Office, General Manager – Development and Community, General Manager – Finance and Business, General Manager – Infrastructure and Environment, Manager Governance and Administration/Minute Taker, Manager Library and Community and Administration and Executive Support Officer be excluded from attendance at the meeting of the Council for Agenda Item 21.1 – *Australia Day Awards 2020*;**
- 2. Council is satisfied that pursuant to section 90(3)(a) of the *Local Government Act 1999*, Item 21.1 – *Australia Day Awards 2020* concerns information of a confidential nature the disclosure of which would involve the unreasonable disclosure of information concerning the personal affairs of any person, constituting information relevant to the nominees’ potential to be awarded relevant Australia Day Awards and it would be unreasonable to disclose this information prior to the determination and announcement of the outcome of the Australia Day Awards; and**
- 3. Council is satisfied that the principle that Council meetings should be conducted in a place open to the public has been outweighed by the need to keep the information, matter and discussion confidential.”**

 Adelaide Plains Council	21.1	Australia Day Awards 2020
	Department: Report Author:	Development and Community Manager Library and Community
Date: 16 December 2019	Document Ref:	D19/58824

EXECUTIVE SUMMARY

- The Australia Day Awards are presented annually to local citizens/community groups that have made outstanding contributions to the community.
- The *Australia Day Council* offers three awards to recognise persons/community groups that have made a significant difference:
 - Citizen of the Year, awarded to the most outstanding Citizen for the APC region
 - Young Citizen of the Year, awarded to the most outstanding Young Citizen for the APC region
 - Community Event of the Year, awarded to the person or group who has staged the most outstanding community event during the past year in the APC region.
- Local government authorities may also offer their own Awards to reflect other achievements in their community. Adelaide Plains Council offers two additional awards:
 - Community Group of the Year, awarded to the group who have made a significant or beneficial contribution to the APC area and/or the community during the past year
 - Community Project of the Year, awarded for projects held entirely or predominantly in the APC region in the past year and organised with the assistance of one or more community groups/members.
- This year Council has received nominations for four of the five awards on offer. There were no nominations received for the Young Citizen of the Year Award.
- Council Members need to deliberate and determine the successful recipients of the Australia Day Awards for 2020. These nominees will receive their Award from Mayor Wasley (or his delegate) on Sunday 26 January 2020 at the Australia Day Ceremony to be held at the Mallala Oval.

RECOMMENDATION 1

“that Council, having considered Item 21.1 – *Australia Day Awards 2020*, dated 16 December 2019, receives and notes the report.”

RECOMMENDATION 2

“that Council, having considered Item 21.1 – *Australia Day Awards 2020*, dated 16 December 2019, determines _____ as the recipient of the Citizen of the Year Award.”

RECOMMENDATION 3

“that Council, having considered Item 21.1 – *Australia Day Awards 2020*, dated 16 December 2019, determines _____ as the recipient of the Community Event of the Year Award.”

RECOMMENDATION 4

“that Council, having considered Item 21.1 – *Australia Day Awards 2020*, dated 16 December 2019, determines _____ as the recipient of the Community Project of the Year Award.”

RECOMMENDATION 5

“that Council, having considered Item 21.1 – *Australia Day Awards 2020*, dated 16 December 2019, determines _____ as the recipient of the Community Group of the Year Award.”

BUDGET IMPACT

Estimated Cost:	Nil
Future ongoing operating costs:	Nil
Is this Budgeted?	Not Applicable

RISK ASSESSMENT

Members need to ensure that all applications are fairly assessed based on the Australia Day Council’s selection criteria. This criteria is detailed in the ‘*Discussion*’ section of this report to assist Members.

An Assessment Form and Matrix has been provided – **Attachment 13** – to assist Members with their determinations. Please note that the comments and scoring are management’s interpretation only. Members are encouraged to ‘score’ all applications prior to the December Ordinary Council meeting.

Attachments

1. Nomination – Citizen(s) of the Year – Craig Argent.
2. Nomination – Citizen(s) of the Year – Rae Corston.
3. Nomination – Citizen(s) of the Year – Stephen and Maxine Cummins.
4. Nomination – Citizen(s) of the Year – Pat Thompson.
5. Nomination – Community Event of the Year – Pinery Fire Memorial Grand Opening, 24 November 2019.
6. Nomination – Community Group of the Year – Adelaide Plains Drama Group.
7. Nomination – Community Group of the Year – Dublin Community Projects.
8. Nomination – Community Group of the Year – Parham and Districts Action Group.
9. Nomination – Community Group of the Year – Two Wells Melodrama Group.
10. Nomination – Community Project of the Year – Dublin Community Projects.
11. Nomination – Community Project of the Year – Parham and Districts Action Group.
12. Nomination – Community Project of the Year – Pinery Fire Memorial and History of Grace Plains.
13. Australia Day Awards – Assessment Form and Matrix.

DETAILED REPORT

Purpose

To provide Council Members with the nominations for the various 2020 *Australia Day Awards*, in order to evaluate and determine the successful recipients.

Background/History

The *Australia Day Awards* are presented annually to local citizens/groups that have made outstanding contributions to the community. The *Awards* are provided by the *Australia Day Council of South Australia* and are administered by Local Government Authorities throughout the State. The successful nominees are notified by administration staff and receive their *Awards* at Council's *Australia Day ceremony*.

Discussion

The *Australia Day Awards* are open to both individuals and groups that have:

- Made a noteworthy contribution to the Adelaide Plains Council on a voluntary basis; or
- Have given an outstanding contribution exceeding their normal employment duties during the current year; and/or
- Provided significant service to the local community over a number of years.

The *Awards* are open to all residents of the Adelaide Plains Council, although contributions made to our community by non-residents will also be considered. Persons or groups previously nominated, but were unsuccessful, may also renominate.

Nominations for the 2020 *Australia Day Awards* opened on Tuesday 1 October 2019 and closed on Friday 15 November 2019 (in line with the *Australia Day Council* guidelines). Nomination forms were available from the Mallala Principal Office, the Two Wells Service Centre and the Two Wells Library. The forms could also be downloaded from the Council website. Advertisements were placed in the *Plains Producer* and *Two Wells Echo*. Management also emailed community groups with the nomination form attached. The *Library Facebook* page also promoted that nominations for the *Australia Day Awards* were open.

The *Australia Day Council's "Guidance and Criteria for Local Authorities"* states:

- *In choosing the recipients of the Awards, regard is given to the nominee's achievement in the year immediately prior to receiving the awards, as well as their past achievements and ongoing contribution to the community.*
- *An individual need only be nominated once to be considered. The number of nominations received per nominee bear no weight in the selection.*

Regarding the above second dot point, please note that one of the nominees for the *Citizen of the Year Award* has been nominated twice.

This document also provides selection criteria for the *Awards*.

The selection criteria for *Citizen of the Year* and *Young Citizen of the Year* are:

- Significant contribution to the community
- An inspirational role model for the Australian community
- The scope of impact the individual's contribution has on the local government area.

This criteria can also apply and extend to Council's category of *Community Group of the Year*.

The selection criteria for *Community Event of the Year* are the:

- Quality of the event
- Scope of impact the event had on the local government area
- Event's contribution to the community.

The above criteria can also apply and extend to Council's category of *Community Project of the Year*.

For the 2020 Australia Day Awards Council received:

Citizen of the Year – five nominations were received. One of the nominees requested that their application be withdrawn. Management referred this matter to the *Australia Day Council's* administration staff and although this was considered 'unusual', it was agreed that the person had the option of not being consideration for this *Award*. Although management spoke to the nominee, the person was still of the same opinion that they did not want to be nominated for this Award and their application was duly withdrawn.

Awarded to the most outstanding Citizen for the Adelaide Plains Council region

Young Citizen of the Year – no nominations were received.

Awarded to the most outstanding Young Citizen for the Adelaide Plains Council region

Community Event of the Year – one nomination was received.

Awarded to the person or group who has staged the most outstanding community event during the past year in the Adelaide Plains Council region

In addition, the Adelaide Plains Council offers two additional Awards:

Adelaide Plains Council Award Categories

Community Group of the Year – four nominations were received.

Awarded to the group who have made a significant or beneficial contribution to the Adelaide Plains Council area and/or the community during the past year

Community Project of the Year – three nominations were received.

Awarded for projects held entirely or predominantly in the Adelaide Plains Council region in the past year and organised with the assistance of one or more community groups/members

After Council Members have made their decisions regarding the successful Award winners, management will contact and inform all these candidates before the Council Offices close on Friday 20 December 2019.

Conclusion

According to the *Australia Day Council* criteria, all nominations submitted to Council meet the eligibility criteria. A decision can therefore be made to determine the following Awards:

- *Citizen of the Year*
 - *Community Event of the Year*
 - *Community Group of the Year*
 - *Community Project of the Year*
-

References

Legislation

Corporations Act 2001

Local Government Act 1999

Public Governance, Performance and Accountability Act 2013

Council Policies/Plans

Strategic Plan 2017-2020

RECOMMENDATION

“that Council, having considered the matter of Agenda Item 21.1 – *Australia Day Awards 2019* in confidence under sections 90(2) and 90(3)(a) of the *Local Government Act 1999*, resolves that:

- 1. The staff report and the minutes pertaining to Agenda 21.1 – *Australia Day Awards 2020* remain confidential and not available for public inspection until all nominees/award recipients have been advised of the outcome;**
- 2. Attachments 1-13 pertaining to Agenda 21.1 – *Australia Day Awards 2020* remain confidential and not available for public inspection until further order of Council;**
- 3. Pursuant to section 91(9)(a) of the *Local Government Act 1999*, the confidentiality of the matter will be reviewed every 12 months; and**
- 4. Pursuant to section 91(9)(c) of the *Local Government Act 1999*, Council delegates the power to revoke this confidentiality order to the Chief Executive Officer.”**

Nomination Form:



Adelaide Plains Council
RECEIVED
13 NOV 2019

Nominee (the person/organisation you would like to nominate)
Please provide as much information as possible. Additional documents may be attached providing further information or testimonials of achievement.

Award Category (please tick)

- CITIZEN YOUNG CITIZEN COMMUNITY EVENT
- COMMUNITY PROJECT COMMUNITY GROUP

Name: *Craig ARSENT*

Address: [Redacted]

Phone: [Redacted] Date of Birth: [Redacted]

Email: [Redacted] YES NO

Reason for nomination
How has the person/organisation contributed to the community?

Please Refer to attached Part "A"

Please list any other significant contributions and/or achievements:

Please Refer to attached Part "B"

Additional material may be attached: maximum five A4 pages, minimum font size 10 point.

Nominator (your details)

Name: [Redacted]

Address: [Redacted]

Email: [Redacted]

I give permission for the Australia Day Council of South Australia to submit this nomination to other recognition programs such as the Australian of the Year Awards.

Please return completed form before Friday 15 November 2019 to:

Anne Sawtell, Library and Community Services Manager, Adelaide Plains Council, PO Box 18, MALLALA SA 5502
Or email info@apc.sa.gov.au

For further information please contact the Manager Library and Community Services on 8527 0200.



Australia Day
**Citizen of the
 year Awards**

Categories:

Citizen of the Year

To be eligible, the person must be an Australian Citizen.

Young Citizen of the Year

To be eligible, the person must be at least 16 years of age, but under 30, on 26 January of the Awards year.

Community Event of the Year

This is presented to the person/group who has staged the most outstanding community event during the past year.

Community Group of the Year

This is presented to the group who have made a significant or beneficial contribution to the local community during the past year.

Community Project of the Year

This is presented to the person/group that has undertaken a significant project during the past year that has benefitted the local community.

**Do you know
 someone** who makes
 your community a
 better place?

Procedure:

Each local Council in South Australia seeks nominations in their local Council area, with the award recipients typically announced at the Council's Australia Day celebrations.

Councils can forward the details of their Award recipients to the Australia Day Council of SA to go in the running for the State Awards, presented by the Governor of South Australia.

The Australia Day Citizen of the Year Awards are proudly presented by the Australia Day Council of South Australia, sponsored by On the Run, Sarah Constructions and Channel 9. The Citizen of the Year Awards are administered by local Councils across SA.

The Awards reward and recognise individuals and organisations that have made a noteworthy contribution during the current year, and/or given outstanding service over a number of years, to a local community over and above normal employment duties.

Outstanding contribution and community service includes areas such as education, health, fundraising, charitable and voluntary services, business, sport, arts, the environment, or any other area that contributes to the advancement and well being of a community. Nominate someone who makes a real difference in your community and give them the opportunity to be rewarded and recognised for their important contribution.

Visit the website:

www.citizenoftheyear.com.au

to nominate online and for more information on the awards, including past winners.

**Australia Day
 Citizen of the
 year Awards**

**Who makes a difference
 in your community?**

Nominations are now open:

- Citizen of the Year
- Young Citizen of the Year
- Community Event of the Year
- Community Group of the Year
- Community Project of the Year

Awards are presented at Australia Day events in Councils across South Australia.

Visit the website or contact your local Council for details.

www.citizenoftheyear.com.au



PART "A" Craig ARGENT

Listed are how Craig has contributed to the Mallala & District community over 30 years since coming to Mallala from Gawler to play Aussie Rules Football.

Mallala Football Club Committee Member 25 years
Granted Life Membership of Club in 2010.

Has organised and compered Football Club very successful reunions.
Team Manager Reserves Team over 10 years.

Was a driving member of the popular Mallala Xmas Street Party which he was also comperc. (Recently taking over by Lions Club.)

Heavily involved in Mallala Bowling Club running the Night Owls competition for many years.

Also has had a few years on stage in Mallala Community Arts Productions

PART "B" Craig ARGENT

Craig purchased Mallala Post Office in 2000.

He is know far and wide for his friendly service and banter which makes visiting the Post Office a pleasure.

Recently with the closure of the Mallala Hospital but the arrival of overseas workers he has gone above and beyond of what is required of a local Post Office.

Craig has been staying open well past closing time to assist the workers with overseas money transactions, sending large parcels etc back to their home.

I feel that after over 30 years of continuous community service Craig would be a worthy recipient and I am nominating him for "Citizen of the Year" Award.

Adelade Plains Council
RECEIVED
12 NOV 2019

To

Anne Sawtell

Library & Community Services Manager.

A.P.C.

Mallala.

re ' Citizen of the Year.

Nomination



Nomination Form:



Adelaide Plains Council
RECEIVED
15 NOV 2019

Nominee (the person/organisation you would like to nominate)

Please provide as much information as possible. Additional documents may be attached providing further information or testimonials of achievement.

Award Category (please tick)

- CITIZEN YOUNG CITIZEN COMMUNITY EVENT
- COMMUNITY PROJECT COMMUNITY GROUP

Name: MRS RAE CORSTON

Address: [REDACTED]

Phone: [REDACTED]

Date of Birth: [REDACTED]

Email:

Is the person being nominated an Australian citizen? YES NO

Reason for nomination

How has the person/organisation contributed to the community?

AS ATTACHED

Please list any other significant contributions and/or achievements:

AS ATTACHED

Additional material may be attached: maximum five A4 pages, minimum font size 10 point.

Nominator (your details)

Name: [REDACTED]

Address: [REDACTED]

Phone: [REDACTED]

Email: [REDACTED]

I give permission for the Australia Day Council of South Australia to submit this nomination to other recognition programs such as the Australian of the Year Awards.

Please return completed form before Friday 15 November 2019 to:

Anne Sawtell, Library and Community Services Manager, Adelaide Plains Council, PO Box 18, MALLALA SA 5502
Or email info@apc.sa.gov.au

For further information please contact the Manager Library and Community Services on 8527 0200.



Australia Day
**Citizen of the
 year Awards**

Categories:

● Citizen of the Year

To be eligible, the person must be an Australian Citizen.

● Young Citizen of the Year

To be eligible, the person must be at least 16 years of age, but under 30, on 26 January of the Awards year.

● Community Event of the Year

This is presented to the person/group who has staged the most outstanding community event during the past year.

● Community Group of the Year

This is presented to the group who have made a significant or beneficial contribution to the local community during the past year.

● Community Project of the Year

This is presented to the person/group that has undertaken a significant project during the past year that has benefitted the local community.

Do you know someone who makes your community a better place?

Procedure:

Each local Council in South Australia seeks nominations in their local Council area, with the award recipients typically announced at the Council's Australia Day celebrations.

Councils can forward the details of their Award recipients to the Australia Day Council of SA to go in the running for the State Awards, presented by the Governor of South Australia.

The Australia Day Citizen of the Year Awards are proudly presented by the Australia Day Council of South Australia, sponsored by On the Run, Sarah Constructions and Channel 9. The Citizen of the Year Awards are administered by local Councils across SA.

The Awards reward and recognise individuals and organisations that have made a noteworthy contribution during the current year, and/or given outstanding service over a number of years, to a local community over and above normal employment duties.

Outstanding contribution and community service includes areas such as education, health, fundraising, charitable and voluntary services, business, sport, arts, the environment, or any other area that contributes to the advancement and well being of a community. Nominate someone who makes a real difference in your community and give them the opportunity to be rewarded and recognised for their important contribution.

Visit the website:

www.citizenoftheyear.com.au

to nominate online and for more information on the awards, including past winners.

Australia Day
**Citizen of the
 year Awards**



**Who makes a difference
 in your community?**

Nominations are now open:

- Citizen of the Year**
- Young Citizen of the Year**
- Community Event of the Year**
- Community Group of the Year**
- Community Project of the Year**

Awards are presented at Australia Day events in Councils across South Australia.

Visit the website or contact your local Council for details.

www.citizenoftheyear.com.au



Media Sponsor

Nomination for Adelaide Plains Council Citizen of the Year Award 2019

Nominee: Mrs Rae Corston, Gawler Rd, Two Wells

Born Lauris Messenger on 19 December 1942, Rae married William Bain Corston in 1964 and settled at Virginia. Bain and Rae had four children, [REDACTED]. Once the children reached school age, Rae volunteered her services at Virginia Primary School from 1972 to 1977 that included canteen duties (preparation, cooking and serving meals), participating with class activities including basket weaving and knitting and as a member of the Parent Committee. At the school's annual sports day Rae assisted with setting up, cooking, cake stalls, canteen and end of day pack up.

In 1975 and 1976 Rae was a valuable member of the Two Wells kindergarten community. She became a parent supervisor, involved in many hands-on activities and in-house events hosted by the Kindy.

During 1977 Rae project managed construction of the family home on Gawler Road, Two Wells. The family moved to Two Wells making it home and embraced community life.

From 1978 to 1984 Rae assisted at Two Wells Primary School as a member of the parent committee, canteen duties, aiding with preparation and running of sports days and grandparents' days and special ceremonies such as the Year 7 Graduation. Rae helped set up for functions, cooked, and was involved in the clean-up and pack-up after each event.

Bain and Rae purchased a sand and metal business in 1983. This included one blue bus and the Two Wells Primary School bus run. Rae drove the bus throughout the district of Two Wells and Lewiston for more than 20 years taking children home safely to family, picking up local high school kids walking home in the rain and provided front door service. Safety of the children was always paramount to Rae and many of the district's children knew Rae through her services as the school bus driver, and as a parent involved in many local sporting clubs as she supported her children and later her grandchildren. Rae was a role model to many due to her community participation.

The Corston bus company grew over the years and is readily recognised by many. The blue and white Corston Coaches have provided discounted passenger services to many clubs, organisations and groups throughout the Adelaide Plains Council area, and commercial services further afield.

Rae has been involved within the community through many clubs and groups within Two Wells and surrounding areas, for over 37 years. Her voluntary services to the clubs have included:

Transport Service - voluntary bus trips inclusive of home baked treats

Two Wells Rotary Club – home catering, meal preparation and event assistance.

Two Wells and District Family History Group – founding member, researcher and recorder of family history including burial and death records for the cemeteries through the Adelaide Plains Council area which was a huge task.

Two Wells Hockey Club - assisted with the establishment of the club, hand stitched team uniforms and provided collection, delivery and transportation of kids to practice and games.

Two Wells Softball Club - Was a founding member and assisted with the establishment of the club, sewed team uniforms and provided transport for coaches and players to and from matches (this club is the oldest and only founding existing club of the Gawler and District Softball Association).

Citizen of the Year Adelaide Plains Council 2019 – Rae Corston

Two Wells and Districts Calisthenics Club – assisted with establishment of the club, and creation of team leotards and competition outfits, including hours of sewing sequins.

Two Wells Football Club – cooked for cake stalls, club events and association functions hosted by the club. Regularly transported players to and from games.

Two Wells Cricket Club – assisted with fundraising through home cooked treats, club dinners and functions. Loyal transporter of children to and from club matches.

Mallala Weight Watchers – member of the committee holding executive roles over the years as secretary and president.

Two Wells Community Centre Committee – active committee member and assisted with functions hosted by the committee by providing support in the kitchen and supplying cooked cakes and treats.

Two Wells Street Parade and Party – made many contributions with the creation of floats and costumes for participants in a range of local clubs and community groups. Provided further support by marching in the parade with children of groups. Cooked many sausage sizzles.

Two Wells Uniting Church – congregation representative, volunteered on many street stalls and provided home cooked treats for fundraising and charity efforts.

Bicentennial Committee – member who participated in the organisation and running of events to celebrate Australia's Bicentennial in 1988.

Two Wells Melodrama Group – Cast Member for annual productions from 1982 to 2013 and a Life Member.

Rae has been a stalwart member of Two Wells Melodrama Group since its inception in 1982. She has performed on stage in a variety of roles in most shows since then, attending rehearsals twice a week for three months of the year, helping with the design and making of costumes, backstage preparations, gathering of props and generally helping others in a supportive way.

Rae's involvement extends as a volunteer to help prepare the hundreds of meals served to Melodrama patrons each year. Each production of six or seven performances over three weekends performing to audiences of up to 1200 patrons each season and at the end of each performance, Rae will be seen out in the main auditorium as tables are being cleared. She quietly gathers all the tablecloths, takes them home, then washes, dries and irons them ready for the next performance. She has done this for many years as she simply wants to help build and maintain a strong local community.

Rae assists her husband Bain and their many staff in running their successful business. She is a mum and grandma to a loving extended family. Over the years she has provided much support through her children's and now grandchildren's involvement in sport. Rae has supported them not just as a spectator but as an active participant in the community and life in general.

Rae continues to volunteer at a community events, visits friends in hospital or in need and provide with meals if needed. Rae is always offering her assistance and providing services in the capacity as a committee member, founding clubs, tailoring uniforms, preparing, cleaning, cooking or tidying up. Never in the spotlight, just going about her ways and achieving much.

Rae is a shining example of what it takes to be a good citizen.

Citizen of the Year Adelaide Plains Council 2019 – Rae Corston



Australia Day Citizen of the year Awards

Categories:

● Citizen of the Year

To be eligible, the person must be an Australian Citizen.

● Young Citizen of the Year

To be eligible, the person must be at least 16 years of age, but under 30, on 26 January of the Awards year.

● Community Event of the Year

This is presented to the person/group who has staged the most outstanding community event during the past year.

● Community Group of the Year

This is presented to the group who have made a significant or beneficial contribution to the local community during the past year.

● Community Project of the Year

This is presented to the person/group that has undertaken a significant project during the past year that has benefitted the local community.

Do you know someone who makes your community a better place?

Procedure:

Each local Council in South Australia seeks nominations in their local Council area, with the award recipients typically announced at the Council's Australia Day celebrations.

Councils can forward the details of their Award recipients to the Australia Day Council of SA to go in the running for the State Awards, presented by the Governor of South Australia.

The Australia Day Citizen of the Year Awards are proudly presented by the Australia Day Council of South Australia, sponsored by On the Run, Sarah Constructions and Channel 9. The Citizen of the Year Awards are administered by local Councils across SA.

The Awards reward and recognise individuals and organisations that have made a noteworthy contribution during the current year, and/or given outstanding service over a number of years, to a local community over and above normal employment duties.

Outstanding contribution and community service includes areas such as education, health, fundraising, charitable and voluntary services, business, sport, arts, the environment, or any other area that contributes to the advancement and well being of a community. Nominate someone who makes a real difference in your community and give them the opportunity to be rewarded and recognised for their important contribution.

Visit the website:

www.citizenoftheyear.com.au

to nominate online and for more information on the awards, including past winners.

Australia Day Citizen of the year Awards



Who makes a difference in your community?

Nominations are now open:

- Citizen of the Year
- Young Citizen of the Year
- Community Event of the Year
- Community Group of the Year
- Community Project of the Year

Awards are presented at Australia Day events in Councils across South Australia.

Visit the website or contact your local Council for details.

www.citizenoftheyear.com.au



In year 2000, Craig Argent purchased the Mallala Post Office and became the officer of the local postal facility as well as one of two local banking agencies in Mallala. He has become a very community oriented & popular identity in our town. His public relations with everybody is well known. Craig is the proprietor of the local Post Office but his daily work goes far beyond what is expected of the usual post master. Campers, caravan people using our Stop-Over Park receive advice in relation to the District, town of Mallala, etc. Back a few years he was one of the organisers to keep the Annual Street Party at Christmas time going (now organised by the Lions Club). He has assisted locals old and young, with day to day budgetting Local teenagers with special needs have been encouraged by giving work experience. He has also been very encouraging & interested in anybody, young or elderly, who has achieved in sport, academia etc. He has willingly given assistance without financial gain. Particularly now and over the last few yearshe has been extremely helpful and friendly to the Vanuatan people who are residing (short term) in the ex-hospital hostel accommodation.....but who are working to earn money for family benefits back home in Vanuatu. He has opened the Post Office for many extra hours (including Saturday mornings) to accommodate their business and needs because of their work schedules.....AND extended the hand of friendship in so-doing. He has been known to show them how to play the sport of Lawn Bowls and taken some out to the oval to enhance their knowledge of Australian Rules football. Having befriended many of the Vanuatans. Craig actually visited Vanuata and was warmly welcomed and recognised for his kindness and assistance to the Vanuatans when living in Mallala on work visas.

Prior to Craig living in Mallala, he had been very involved with the Mallala Football Club as a player and volunteer. In 1988, he joined the Football club & in ensuing years played in A & B grade. However, his main involvement soon became via the Social Club & has organised many Premiership Reunions including a very well attended one this year, money raising affairs, particularly when the extensions to the clubrooms occurred. He has held various positions, Ass. Secretary, Chairman & organiser of the Social Committee & awarded 'Magpie for the year 1997'.

A great person to have around the football club and a Citizen of our town of Mallala”full of humour, always stirring or being stirred.” !!!

I needed to ascertain information re Mr. Craig Argent and therefore chatted with a few residents in Mallala .

These residents all indicated that they would like to endorse the Nomination of Mr. Craig Argent for “CITIZEN OF THE YEAR, 2019” and indicated that they would like to endorse and sign the nomination formso they did !
Some signatures are not ‘clear’ but their names are listed herewith

[REDACTED]

orientated

and

In year 2000, Craig Argent purchased the Mallala Post Office & became the officer of the local postal facility as well as one of two local banking agencies in Mallala. He has become a very community & popular identity in our town. His public relations with everybody is well known. Campers, caravan people using our Stop-Over Park receive advice re the District, town of Mallala etc. Back a few years he was one of the organisers to keep the Annual Street Party at Christmas time going (now organised by the Lions Club). He has assisted locals old and young, with financial affairs. Local teenagers with special needs have been encouraged by giving work experience. He Also been very encouraging & interested in anybody who has achieved in sport, academia etc.

in relation

day to day budgeting

He has willingly given assistance without financial gain. . Particularly now and over the last few yearshe has been extremely helpful & friendly to the Vanuatan people who are residing (short term) in the ex-hospital hostel accommodation.....but working to earn money for family benefits back home in Vanuatu. He has opened the Post Office for many extra hours (including Saturday mornings) to accommodate their business & needs because of their work schedules.....AND extended the hand of friendship in so-doing. He has been known to show them how to play the sport of Lawn Bowls and taken some out to the oval to enhance their knowledge of Australian Rules football. Having befriended many of the Vanuatans, he actually visited Vanuata and was warmly welcomed and recognised for his kindness and assistance to the Vanuatans when living in Mallala on work visas.

to many ppl

living

Prior to Craig becoming a citizen of Mallala, he had been very involved with the Mallala Football Club as a player and volunteer. In 1988, he joined the Football club & in ensuing years played in A & B grade. However, his main involvement soon became via the Social Club & has organised many Premiership Reunions including a very well attended one this year, money raising affairs, particularly when the extensions to the clubrooms occurred. He has held various positions, Ass. Secretary, Chairman & organiser of the Social Committee & awarded 'Magpie for the year 1997'.

A great person to have around the club and a Citizen of our town of Mallala
.....!!..full of humour, always stirring or being stirred. !!! !!



Australia Day Citizen of the year Awards

Categories:

Citizen of the Year

To be eligible, the person must be an Australian Citizen.

Young Citizen of the Year

To be eligible, the person must be at least 16 years of age, but under 30, on 26 January of the Awards year.

Community Event of the Year

This is presented to the person/group who has staged the most outstanding community event during the past year.

Community Group of the Year

This is presented to the group who have made a significant or beneficial contribution to the local community during the past year.

Community Project of the Year

This is presented to the person/group that has undertaken a significant project during the past year that has benefitted the local community.

**Do you know
someone** who makes
your community a
better place?

Procedure:

Each local Council in South Australia seeks nominations in their local Council area, with the award recipients typically announced at the Council's Australia Day celebrations.

Councils can forward the details of their Award recipients to the Australia Day Council of SA to go in the running for the State Awards, presented by the Governor of South Australia.

The Australia Day Citizen of the Year Awards are proudly presented by the Australia Day Council of South Australia, sponsored by On the Run, Sarah Constructions and Channel 9. The Citizen of the Year Awards are administered by local Councils across SA.

The Awards reward and recognise individuals and organisations that have made a noteworthy contribution during the current year, and/or given outstanding service over a number of years, to a local community over and above normal employment duties.

Outstanding contribution and community service includes areas such as education, health, fundraising, charitable and voluntary services, business, sport, arts, the environment, or any other area that contributes to the advancement and well being of a community. Nominate someone who makes a real difference in your community and give them the opportunity to be rewarded and recognised for their important contribution.

Visit the website:

www.citizenoftheyear.com.au





to nominate online and for more information on the awards, including past winners.

Australia Day Citizen of the year Awards



Who makes a difference in your community?

Nominations are now open:

-  Citizen of the Year
-  Young Citizen of the Year
-  Community Event of the Year
-  Community Group of the Year
-  Community Project of the Year

Awards are presented at Australia Day events in Councils across South Australia.

Visit the website or contact your local Council for details.

www.citizenoftheyear.com.au



Both Maxine and Steve are willing workers in our community.

Steve has been involved with the Two Wells Scout Group for around 25 years with Maxine joining him about 10 years ago.

Steve has been managing the scoreboard for the Two Wells Football Club for around 10 years and in the past 2 years has undertaken the same role at Virginia Football Oval, with any money received donated to the Scouts.

Maxine has taken the role of gatekeeper at the Two Wells Football Oval for around 10 years, donating any money received to the Scouts.

Steve collects cans and bottles around the township for Scouts, counting and taking them to the collection depot.

Both have worked in the kitchen at the TW Melodrama for about 25 years where Steve can be found at the sink at every performance.

Steve is a Volunteer for 'Fred's Van' in Salisbury, a catholic organisation providing meals for the underprivileged.

Maxine volunteers at the Uniting Church Op-Shop and both are members of the Uniting Church.

Steve and Maxine foster a child with a disability. Both are always willing to lend a hand wherever it is needed and are both a great asset to our community.

Nomination Form:



Adelaide Plains Council
RECEIVED
15 NOV 2019

Nominee (the person/organisation you would like to nominate)

Please provide as much information as possible. Additional documents may be attached providing further information or testimonials of achievement.

Award Category (please tick)

- CITIZEN
- YOUNG CITIZEN
- COMMUNITY EVENT
- COMMUNITY PROJECT
- COMMUNITY GROUP

Name: PAT THOMPSON

Address: [Redacted]

Phone: [Redacted]

Date of Birth: [Redacted]

Email: [Redacted]

Is the person being nominated an Australian citizen? YES NO

Reason for nomination EXTRAORDINARY Efforts for the Community
How has the person/organisation contributed to the community?

GREAT CONTRIBUTION TO CEMETRIES of Dublin IRELAND
 MONIES RAISED for AND SAVED Dublin DESPATCH
 ORGANIZING ROSE GARDEN AND GARDEN EXPOSES
 WAR MEMORIAL by ROSE GARDEN RESPONSIBLE for Dublin history group FOUNDED
 AND NUMEROUS OTHER Effort for Community benefits

Please list any other significant contributions and/or achievements:

TREE-PLANTATION for WORLD WAR I SOLDIERS at Dublin IRELAND
 SHANNON CEMETRY HISTORICAL PHOTO AND IN MEMORY of
 ORIGINAL CHURCH (Now REMOVED)
 MANY HOURS of RESEARCH & MONEY RAISING UNSELFISHLY
 TRULY A REMARKABLE EFFORT OVER MANY YEARS

Additional material may be attached: maximum five A4 pages, minimum font size 10 point.

Nominator (your details)

Name: [Redacted]

Address: [Redacted]

[Redacted]

Email: [Redacted]

I give permission for the Australia Day Council of South Australia to submit this nomination to other recognition programs such as the Australian of the Year Awards.

Please return completed form before Friday 15 November 2019 to:

Anne Sawtell, Library and Community Services Manager, Adelaide Plains Council, PO Box 18, MALLALA SA 5502

Or email info@apc.sa.gov.au

For further information please contact the Manager Library and Community Services on 8527 0200.



Australia Day
**Citizen of the
 year Awards**

Categories:

Citizen of the Year

To be eligible, the person must be an Australian Citizen.

Young Citizen of the Year

To be eligible, the person must be at least 16 years of age, but under 30, on 26 January of the Awards year.

Community Event of the Year

This is presented to the person/group who has staged the most outstanding community event during the past year.

Community Group of the Year

This is presented to the group who have made a significant or beneficial contribution to the local community during the past year.

Community Project of the Year

This is presented to the person/group that has undertaken a significant project during the past year that has benefitted the local community.

**Do you know
 someone** who makes
 your community a
 better place?

Procedure:

Each local Council in South Australia seeks nominations in their local Council area, with the award recipients typically announced at the Council's Australia Day celebrations.

Councils can forward the details of their Award recipients to the Australia Day Council of SA to go in the running for the State Awards, presented by the Governor of South Australia.

The Australia Day Citizen of the Year Awards are proudly presented by the Australia Day Council of South Australia, sponsored by On the Run, Sarah Constructions and Channel 9. The Citizen of the Year Awards are administered by local Councils across SA.

The Awards reward and recognise individuals and organisations that have made a noteworthy contribution during the current year, and/or given outstanding service over a number of years, to a local community over and above normal employment duties.

Outstanding contribution and community service includes areas such as education, health, fundraising, charitable and voluntary services, business, sport, arts, the environment, or any other area that contributes to the advancement and well being of a community. Nominate someone who makes a real difference in your community and give them the opportunity to be rewarded and recognised for their important contribution.

Visit the website:

www.citizenoftheyear.com.au

to nominate online and for more information on the awards, including past winners.

Australia Day
**Citizen of the
 year Awards**



**Who makes a difference
 in your community?**

Nominations are now open:

- Citizen of the Year
- Young Citizen of the Year
- Community Event of the Year
- Community Group of the Year
- Community Project of the Year

Awards are presented at Australia Day events in Councils across South Australia.

Visit the website or contact your local Council for details.

www.citizenoftheyear.com.au



Nomination Form:



Nominee (the person/organisation you would like to nominate)

Please provide as much information as possible. Additional documents may be attached providing further information or testimonials of achievement.

Award Category (please tick)

- CITIZEN YOUNG CITIZEN COMMUNITY EVENT
 COMMUNITY PROJECT COMMUNITY GROUP

Name:

PINERY FIRE MEMORIAL GRAND OPENING

Address:

[REDACTED]

Phone:

Date of Birth:

N/A

Email:

Is the person being nominated an Australian citizen? YES NO

Reason for nomination

How has the person/organisation contributed to the community?

REFER TO ATTACHED

Please list any other significant contributions and/or achievements:

REFER TO ATTACHED

Additional material may be attached: maximum five A4 pages, minimum font size 10 point.

Nominator (your details)

Name:

[REDACTED]

Address:

[REDACTED]

Phone:

[REDACTED]

Email:

[REDACTED]

I give permission for the Australia Day Council of South Australia to submit this nomination to other recognition programs such as the Australian of the Year Awards.

Please return completed form before Friday 15 November 2019 to:

Anne Sawtell, Library and Community Services Manager, Adelaide Plains Council, PO Box 18, MALLALA SA 5502
Or email info@apc.sa.gov.au

For further information please contact the Manager Library and Community Services on 8527 0200.

NOMINATION FOR AUSTRALIA DAY AWARDS - 2020

COMMUNITY EVENT

'PINERY FIRE MEMORIAL GRAND OPENING'

HOW HAS THE EVENT CONTRIBUTED TO THE COMMUNITY?

This is an outstanding community event that has pulled together the efforts of 100's of individuals, local community members, businesses, local Lions Club and literally 1,000's of hours over a 3.5 year period.

Victims and communities impacted by the Pinery Fire have worked together to develop a commemorative memorial, which will be unveiled in recognition of the fourth anniversary of the devastating Pinery Fire.

This event is the culmination of a significant number of both community members and businesses, which I believe will add to the mental wellbeing of the whole community. The displays show not only the devastation but that fact that together, recovery can occur.

While the Opening Event is focussed on the commemoration and remembrance of those that lost their lives in this devastating event, this is also a time to recognise the history and strength of all concerned.

With the attendance of some of the farm units and the CFS units that were on the ground during the days and weeks of the event and the aftermath, there will be a sense of connection and resolution to the Event.

The memorial launch, which recognises and remembers the impact, lives lost and devastation of the Pinery Fire, will be held on the Eve of the anniversary of the Pinery Fire - Sunday the 24th of November at the Grace Plains Memorial Site (near the township of Mallala).

While at the time of submitting this nomination the Event is yet to be held, based on invitation replies, it is expected that there may be approximately 500 persons in attendance at the official opening.

Attendees will include those affected by the fire that left the area due to the trauma and impact on their lives, it is hoped that this will assist with closure and recognition of those affected by this devastating fire.

These efforts have been initiated and project managed by the *Moquet Lee Trustees*, with the Chairperson, Mr Peter March, being one of the main drivers and backbone of the Event.

A plaque will be unveiled by the *Hon. Corey Wingard MP, Minister for Police, Emergency Services and Correctional Services, Recreation, Sport and Racing*.

THE NOMINATED EVENT:

THE OPENING OF THE PINERY FIRE MEMORIAL



Victims and communities impacted by the Pinery Fire have worked together to develop a significant commemorative memorial, which will be unveiled in recognition of the fourth anniversary of the devastating bushfire.

The memorial launch, which recognises and remembers the impact, lives lost and devastation of the Pinery Fire, will be held on the Eve of the anniversary of the Pinery Fire, Sunday the 24th of November at the Grace Plains Memorial Site (near the township of Mallala) at 2:00pm.

The MEMORIAL

The memorial site has been constructed by community members and between local donations and community grants. It is a true community project and simply would not have been possible without the generosity of local community members and businesses.

Around 270 photos and memorabilia will be on display

The displays will cover 21m X 1.2m which is about 25m² of reading material

WHY THE MEMORIAL?

A memorial is needed to remember and recognise the impact of the fires on our community in a factual and respectful way and pay respects to the lives lost.

It is also important to recognise and pay tribute to, the life of Private Fred Nairn and the history of the Grace Plains district with historic photos and content showcasing the original settlement.

WHERE IS IT?

The Moquet Lee Pinery Fire Memorial is situated at Grace Plains at the rear of the former Methodist Church and Cemetery, 8 km north of Mallala.

The day will feature a series of talks by community members, fire recovery teams and more.

An area immediately opposite the site will showcase some of the CFS fire units and farmer units who battled the inferno.

Please note: should you require more details of the exact number of persons involved or the names of volunteers who have assisted, please contact Mr Peter March, Chairperson, Moquet Lee Trustees

NOMINATION FOR AUSTRALIA DAY AWARDS - 2020
COMMUNITY EVENT –UPDATED INFORMATION

'PINERY FIRE MEMORIAL GRAND OPENING'

HOW HAS THE EVENT CONTRIBUTED TO THE COMMUNITY?

This is an outstanding community event that has pulled together the efforts of 100's of individuals, local community members, businesses, local Lions Club and literally 1,000's of hours.

On Sunday 24th of November, the Grace Plains community coordinated a community event to remember and commemorate the Pinery Fire which devastated the Adelaide Plains community four years ago.

The memorial is located at Grace Plains on the corner of Traeger Road and Nairn Road, and commemorates the lives of Allan Tiller and Janet Hughes who were killed by the fire.

The memorial was a respectful and engaging event which brought together a range of speakers who shared their stories, experiences and pathways to recovery after the fire.

“It was a reunion of victims, other community members and those who came to the region to carry out the recovery response and provide essential support. We are continually thankful and grateful for everything – thank you sincerely for all of your kindness”.

The memorial would not have been possible without the generosity of community members and businesses, plus the dedication of many families who turned up for working bees.

“We simply cannot thank our community members enough for their hard work and dedication to make this memorial a success. They have committed so much time and effort – we are very thankful for their work. The people behind the scenes are the unsung heroes in all of this and they are proud of what was achieved”.

The Mallala Lions Club have stood beside us all of the way, and have been of great assistance.

The memorial plaque which was donated by Cook Memorials, was unveiled by The Honourable Corey Wingard MP, Minister for Police, Emergency Services and Correctional Services.

Over 400+ people attended the memorial, and viewed the newly erected display which shows over 270 photos which remember not only the Pinery fire, but remember the History of the Grace Plains region; this display covers 40 square metres.

The CFS was well represented with a range of CFS fire fighting units and farm fire fighting units, and created a magnificent backdrop for the event.





Guest speakers included:

- Peter March - Chair of Moquet Lee Grace Plains
- John Lush - Mallala Councillor
- Di Adams – Registered Nurse on Duty at the Hamley Bridge Hospital
- Vince Monterola – Pinery Fire Recovery Coordinator
- Kelvin Tiller - Pinery - Son of Allan
- Val Hammatt- Barabba- Sister of Janet
- The Honourable Corey Wingard MP, Minister for Police, Emergency Services and Correctional Services.

The event attracted visitors from New South Wales, Victoria, Eyre Peninsula, Mid North , South East, Murray Mallee, Victor Harbor, Adelaide and neighbouring districts.



Many favourable comments were received on the day, and due to the size of the display many have indicated that they will return with their friends at a later date to view it in detail at their leisure.



Thank you to Mallala and Districts Lions Club for their assistance during the project and for providing refreshments at the Event



Officials and Speakers



Main display area



Over 200 people seated in the RAA Pavilion



The plaque is unveiled





The memorial is open and free to the public all day, every day and we encourage anyone including schools, community groups, tourists and the general public to drop in at any time.

The site has 7 different aspects to it:

- The Pinery Fire Memorial as the focal point.
- The tribute to Fred Nairn from which the Moquet Lee name is derived.
- 150 years of the history of Grace Plains is also on display and will be of interest to many people
- The hard work of the Grace Plains community since the fire 4 years ago has been recognised in the "Pavilion" with pictorial and written display, and has a board recognising the financial contributors. A display featuring the events of opening day have been added since the event.
- The donated 216,000 litre fire fighting tank installed at the rear is a part of the planning to help protect our community if an event similar to the Pinery fire occurs in future. This tank is equipped to handle CFS trucks and farm fire fighting vehicles at separate points.
- The cemetery which was substantially damaged in the fire, and partially buried with the subsequent 6 months of sand drifting into it from the bare paddocks has been cleaned and re fenced in co operation with the Adelaide Plains Council with a structure which replicates the original fence around the former Grace Plains Church which is adjacent to the site. Council supplied the material and we erected the fence with our own voluntary labour. New entrance gates and an arch have been designed, erected and paid for by our residents, and we also organised for the whole area to be coated with a layer of gravel. We also arranged for all of the headstones to be professionally cleaned. This has resulted in a total transformation and resulted in many favourable comments on the day.
- The 7th aspect was completed as a result of the Federal Drought Fund Grant which allowed us to provide a neat clean surface on what were the old tennis courts, and to lay a bitumen surround at the fire fighting tank so that CFS and farm units are not working under unsafe and muddy conditions

Nomination Form:

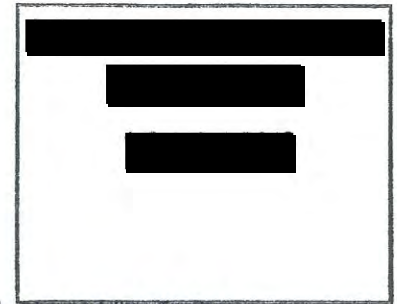

Nominee (the person/organisation you would like to nominate)

Please provide as much information as possible. Additional documents may be attached providing further information or testimonials of achievement.

Award Category (please tick)

- CITIZEN
- YOUNG CITIZEN
- COMMUNITY EVENT
- COMMUNITY PROJECT
- COMMUNITY GROUP

Name: *Adelaide Plains Drama Group*

Address: [Redacted]

Phone: [Redacted]

Date of Birth: [Redacted]

Email: [Redacted]

Is the person being nominated an Australian citizen? YES NO

Reason for nomination

How has the person/organisation contributed to the community?

Please list any other significant contributions and/or achievements:

Since the group have started the children involved have learnt respect, confidence to have ago and support each other. Not all children wish to play sport but the drama class enables the group to gather and build friendship and teamwork

Additional material may be attached: maximum five A4 pages, minimum font size 10 point.

Nominator (your details)

Name: [Redacted]

Address: [Redacted]

Phone: [Redacted]

Email: [Redacted]

I give permission for the Australia Day Council of South Australia to submit this nomination to other recognition programs such as the Australian of the Year Awards.

Please return completed form before Friday 15 November 2019 to:

Anne Sawtell, Library and Community Services Manager, Adelaide Plains Council, PO Box 18, MALLALA SA 5502
Or email info@apc.sa.gov.au

For further information please contact the Manager Library and Community Services on 8527 0200.



Australia Day Citizen of the year Awards

Categories:

Citizen of the Year

To be eligible, the person must be an Australian Citizen.

Young Citizen of the Year

To be eligible, the person must be at least 16 years of age, but under 30, on 26 January of the Awards year.

Community Event of the Year

This is presented to the person/group who has staged the most outstanding community event during the past year.

Community Group of the Year

This is presented to the group who have made a significant or beneficial contribution to the local community during the past year.

Community Project of the Year

This is presented to the person/group that has undertaken a significant project during the past year that has benefitted the local community.

Do you know someone who makes your community a better place?

Procedure:

Each local Council in South Australia seeks nominations in their local Council area, with the award recipients typically announced at the Council's Australia Day celebrations.

Councils can forward the details of their Award recipients to the Australia Day Council of SA to go in the running for the State Awards, presented by the Governor of South Australia.

The Australia Day Citizen of the Year Awards are proudly presented by the Australia Day Council of South Australia, sponsored by On the Run, Sarah Constructions and Channel 9. The Citizen of the Year Awards are administered by local Councils across SA.

The Awards reward and recognise individuals and organisations that have made a noteworthy contribution during the current year, and/or given outstanding service over a number of years, to a local community over and above normal employment duties.

Outstanding contribution and community service includes areas such as education, health, fundraising, charitable and voluntary services, business, sport, arts, the environment, or any other area that contributes to the advancement and well being of a community. Nominate someone who makes a real difference in your community and give them the opportunity to be rewarded and recognised for their important contribution.

Visit the website:

www.citizenoftheyear.com.au





to nominate online and for more information on the awards, including past winners.

Australia Day Citizen of the year Awards



Who makes a difference in your community?

Nominations are now open:

-  Citizen of the Year
-  Young Citizen of the Year
-  Community Event of the Year
-  Community Group of the Year
-  Community Project of the Year

Awards are presented at Australia Day events in Councils across South Australia.

Visit the website or contact your local Council for details.

www.citizenoftheyear.com.au



How has the person/organisation contributed to the community

Adelaide Plains Drama Group was established 2017 by Amanda and Casey Birns. at Mallala.

Drama group is a small group of local children aged 7-12 years. Who meet once a week during school terms. We have competed in Balaklava, Estedford and Now Talent and have been successful.

Adelaide Plains Council
RECEIVED
15 NOV 2019

Nomination Form:



Nominee (the person/organisation you would like to nominate)

Please provide as much information as possible. Additional documents may be attached providing further information or testimonials of achievement.

Award Category (please tick)

- CITIZEN
- YOUNG CITIZEN
- COMMUNITY EVENT
- COMMUNITY PROJECT
- COMMUNITY GROUP

Name: *Dublin Community Projects.*

Address: [Redacted]

Phone: [Redacted]

Date of Birth:

Email: [Redacted]

Is the person/organisation a resident of the Adelaide Plains Council area? YES NO

Reason for nomination

How has the person/organisation contributed to the community?

Supports community groups within our Dublin area, and finances special projects. Documentation with details included.

Please list any other significant contributions and/or achievements:

Documented separately.

Additional material may be attached: maximum five A4 pages, minimum font size 10 point.

Nominator (your details)

Name: [Redacted]

Address: [Redacted]

Phone: [Redacted]

Email:

I give permission for the Australia Day Council of South Australia to submit this nomination to other recognition programs such as the Australian of the Year Awards.

Please return completed form before Friday 15 November 2019 to:

Anne Sawtell, Library and Community Services Manager, Adelaide Plains Council, PO Box 18, MALLALA SA 5502
Or email info@apc.sa.gov.au

For further information please contact the Manager Library and Community Services on 8527 0200.

MONIES DONATED BY DUBLIN COMMUNITY PROJECTS

- 2013** Contribution towards DHG WW1 Memorial Tree project --remaining monies from
The New Dublin Cemetery fence and gate restoration project
- 2014** Purchase of a bench seat at Dublin Cemetery
Purchase of glass display cabinets for the Dublin History Group
Contribution towards the Memorial garden at the Dublin Institute
Assist with funding of blinds for the Dublin Institute
Restoration of Dublin Institute coach lights
- 2015** Purchase of WW1 soldiers dossiers and stationery for the Dublin History Group
Purchase of pie warmer for the Dublin Cricket Club
Contribution towards stove for the Thompson Beach Progress Ass. Club rooms
- 2016** Restoration of framed items for the Dublin History Group
- 2017** Contribution towards the purchase and installation of an air conditioner for the
Dublin Institute
Purchase of a bench seat at Dublin Cemetery
Purchase of an honour board for the Dublin History Group
Replacement of stolen Lions Park time capsule plaque in Dublin
Purchase of document storage items for the Dublin History Group
Purchase of membership medallions for the Port Parham Littlies Theatrical Group
Donation to the Avon Art and Craft Group
- 2018** Purchase and installation of blinds in the Windsor Institute
Donation to the Dublin CFS extension appeal
Purchase of photographic paper and ink for the Dublin History Group Institutes project
Purchase of storage containers for the Dublin History Group
Purchase of a fridge for the Thompson Beach Progress Association
Transfer of videos to cd for the Dublin History Group
Installation of Plot Map Boards for both Shannon (Long Plains) and Dublin Cemeteries
- 2019** Installation and unveiling of an historical plaque by Mrs Beryl Wilson and Mr Mark
Wasley, Mayor, Adelaide Plains Council on 15 9 2019 giving the history together with a
photograph of the church, for both the former Shannon Methodist Church and the
Shannon Cemetery,

To date since 2013 in total of \$14, 933-27 has been raised and donated

A few brief details of the planning and dedication of the former Shannon Methodist Church and Cemetery Historical Plaque 15th September 2019-11-14 that took several years to materialise

Arranged and funded by Dublin Community Project members ---Anthea Ailmore, Ian Telfer, Pat Thompson and for this project only were joined by Chris Jenkin and Gwen Secomb Meetings were held regularly for several months in the cafe of the Dublin General Store.

Lower Light's sign writer Max of Original Signs designed and made the historical plaque for a cost of \$17500.

Monies were raised through the sale of jams, pickles. plants . Christmas Lolly Trees, a raffle , cushions, babies patchwork cot covers/floor rugs etc.

Local Dublin business's together with the Pt Parham Sports and Social Club Inc. committee support Dublin Community Projects by selling items and produce that assists greatly with the raising of finance.

The support received from council senior staff members, Alison Down and Tom Jones was both most helpful and greatly appreciated.

The Mallala Museum committee lent the original Shannon Church front door for this special occasion.

Long Plains Red Cross members catered with a delicious afternoon tea in the Long Plains Memorial Hall. for the one hundred plus people who attended. A gold coin donation was requested on each invitation.

Many photographs were bought along for Bill Field to copy that both the Dublin History Group Inc, and Mallala Museum committee with receive copies of, as they also will of all photographs taken on the day . Gwen Secomb has taken on the responsibility of co-ordinating all information/ photographs received for both organisations .

There has been a large amount of positive feedback received over these past weeks from a number of former residents who attended –some travelled from interstate and far off SA country towns..

Thankyou for reading my brief account of the 15th September 2019-11-15

On behalf of Anthea Ailmore, Gwen Secomb, Chris Jenkin, Ian Telfer

Regards Pat Thompson
Dublin Community Projects

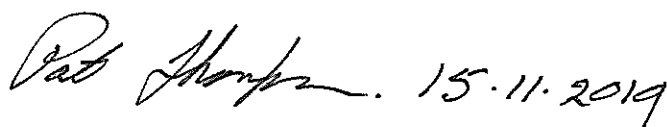

Pat Thompson. 15.11.2019

Dublin Community Projects



The committee invites



To attend the Unveiling of a plaque
providing the history of the
Shannon Methodist Church and Cemetery at Calomba
by Mrs Beryl Wilson and Mr Chris Jenkin
on **Sunday 15th September 2019** at **2:30 pm**

To assist with seating, please bring a chair.

Afternoon tea will be provided by the Long Plains Red Cross members
after the ceremony in the Long Plains Soldiers Memorial Hall
(gold coin donation)

RSVP by 7th September to Pat Thompson
Ph. 8529 2028 or DublinCommunityProjects@gmail.com

To assist with collecting our local history, it would be appreciated if any photos or documents relating to people, businesses, events and buildings in the Calomba, Dublin, Long Plain, Lower Light, Shannon, Wild Horse Plains and Windsor districts, as well as the coastal area from Parham to Port Prime. Copying facilities will be available on the day.

Shannon brought back to life

Louise Michael reports:

SHANNON was brought to life on Sunday, September 15 as a large crowd gathered for the official opening of an impressive plaque providing the history of the former Shannon Methodist church and cemetery.

MC Ian Telfer welcomed everyone, including descendants of former residents, before Adelaide Plains Council mayor, Mark Wasley, Fraser Ellis MP, and Rev Dr Phillip Marshall gave short speeches, before the plaque with history from 1873 to 1966, was unveiled by Beryl Wilson and Chris Jenkin.

The plaque was instigated by Dublin Community Projects. Rev Dr Phil, Mr Ellis and Mr Wasley then each planted a tree in the cemetery grounds after the dedication.

Parham Singers led the singing of the hymn, All Things Bright and Beautiful, sung with gusto!

After the ceremony, everyone went to the Long Plains hall to browse through displays of old photos and memorabilia. One item of interest was the original front door of the Shannon Church, lent for the day by Mallala Museum.

Bill Field was on hand to scan photos for people, with copies also made for the Mallala Museum and Dublin History Group. A delicious afternoon tea, provided by the Long Plains Red Cross, was enjoyed by everyone.



Chris Jenkin helps Beryl Wilson unveil the new plaque.



Margaret March, Beryl Wilson (nee Rowe) and Ruth Symons. Margaret was flowergirl in Beryl's wedding, and Beryl is the only surviving Rowe family member who was married in the church.



Chris Jenkin and Allan Parker planting a tree.



The history plaque.



Nita Noble, Gwenda Griffiths and Lois Wasley.



Ellen Gilbert and Lois Williams-Pinchbeck.

MacKenzie Homes & Commercial Pty Ltd

**CUSTOM BUILT HOMES
ADDITIONS AND
RENOVATIONS**

HIA GreenSmart PROFESSIONAL

'Greensmart Energy Efficiency'



Pat Thompson and Gwen Secomb looking at photos pinned on the original door of the Shannon Methodist Church.



Max and Ruth Symons, Beryl Wilson, Milton and Ruth Rowe.

BOLTS ON SALE

NO, NOT THOSE!

THESE!

25% OFF

WHEN YOU BUY

SHANNON METHODIST CHURCH

1873 - 1966

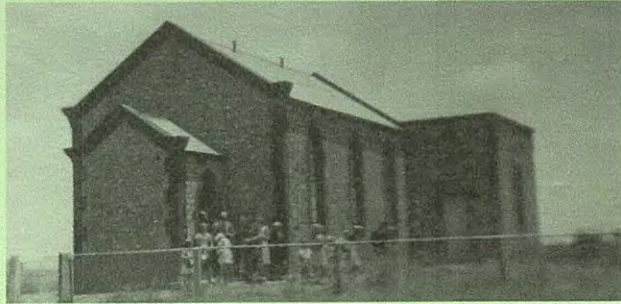

The following was documented on the church's original history. The foundation stone of the Shannon Methodist Chapel in the name of God the Father, Son and the Holy Spirit, by Joshua Marshman of Mallala on the 8th day of October year of our Lord. One Thousand eight hundred and seventy two (1872) being the thirty sixth year of her most gracious Majesty Queen Victoria His Excellency the Right Honourable Sir James Wayland being the Governor of the Province of South Australia, the Rev. James Stewart Wayland and Steven James Nicholls being ministers of the circuit, Mr Henry Nicholls being the circuit steward, and Charles Bruce Carslake, Robert Cooper, James Davis, Steven Davis, George Nicholas Johnson, Noble Johnson Weatherall-Lindsay and John Thomas Sutton being the trustees of the chapel. May God bless this undertaking John Wayland 8th October 1872.

 1873 - The Primitive Methodist Church was officially opened on 17th July by Joshua Marshman of Mallala on land donated by the Wright brothers in an area known as 30 mile scrub in the hundred of Dublin. Previously, worship was held in homes of Messrs Johnson and Baker. Specifications of the building were completed by Rev. J. S. Wayland. The church, was constructed of local stone with six gothic windows and a porch, was built by Mr Johnathon Porter, the woodwork by Mr Joseph Smith and the furnishings made by Mr Uffindale. It had a capacity of 140 people.

 1901 - The church joined the Methodist Union.

 1908 - A T shaped addition to the western wall was built by Mr T Burton to accommodate the Sunday School.



1922 - The land on the eastern boundary was purchased from the Roy family for a nominal figure, to create the triangle shape it is today.



1923 - Mr Hartley was elected curator of the cemetery adjacent to the church. The Jubilee of the Shannon Methodist Church was held over several days and on Sunday 23rd July two services were held with Rev. A.W. Wellin.



1957 - Due to declining numbers attending, the church was closed.



1966 - Fearing the church would be vandalised, the trustees agreed to demolition. The demolition was done with the greatest of care, by Mr Ira, Mervin & Neville Jenkin, as it was understood that a bottle containing items of historical importance was held in the building. The bottle was eventually found where the porch and the church walls met. Mr Mervin Jenkin took the bottle to the Long Plains school the next day and told the children about the history associated with Shannon. At the time the District Council of Mallala took over management of the Shannon Cemetery.



1977 - A cairn was built on the site of the Shannon Methodist Church and on April 17th 1977, the plaque was unveiled by Mr Frank Johnson. A time capsule was inserted into the cairn at its unveiling.



1984 - Mr Allan Parker organised the planting of native trees by the Mallala Greening Group members and volunteers both on church grounds and eastern boundary.



2005 - The "Shannon Cemetery" sign was built and erected by Basset Welding & Fabrication, Lewiston.



2010 - Due to the popularity of cremations over burials, a columbarium was erected on the northern boundary to cater for this demand. The Rev. Jewell officiated at the dedication ceremony on the 11th April and Mr M Secomb OAM was the master of ceremonies. Later that year, the Mallala Club donated a seat opposite the columbarium.



2018 - Cemetery plot map board initiated by Dublin Community Project and installed by Adelaide Plains Council.



2019 - This plaque was jointly unveiled on 15 Sept. 2019 by Mrs Bery and Mr Chris Jenkin. Robert Bushell laid the foundation for the plaque by Original Signs. The plaque was financed by the community through Community Projects under the umbrella of the Adelaide Plains Council.

Rowe Road

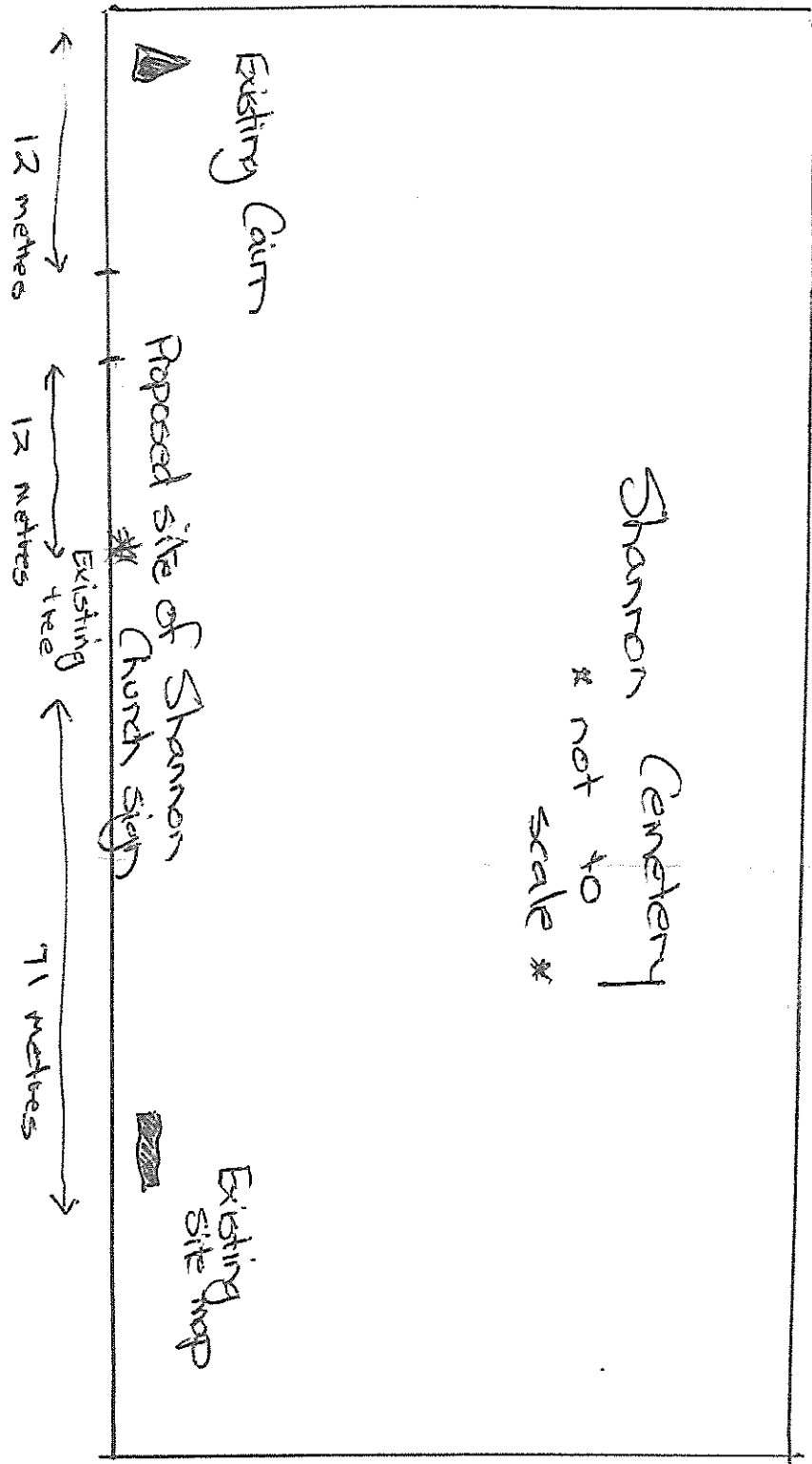

Shannon Cemetery
* not to scale *

Existing Cairn

Proposed site of Shannon Church sign

Existing site map

12 metres

12 metres

71 metres

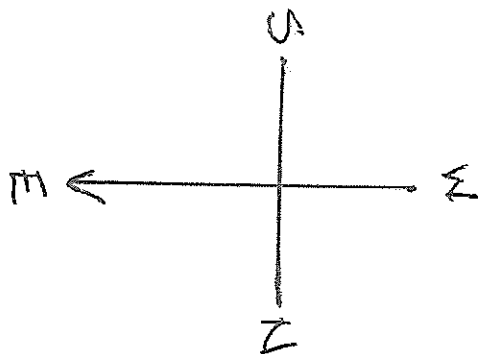

Height of existing fence
900 mm.

SIGN TO FIT INSIDE FRAMEWORK

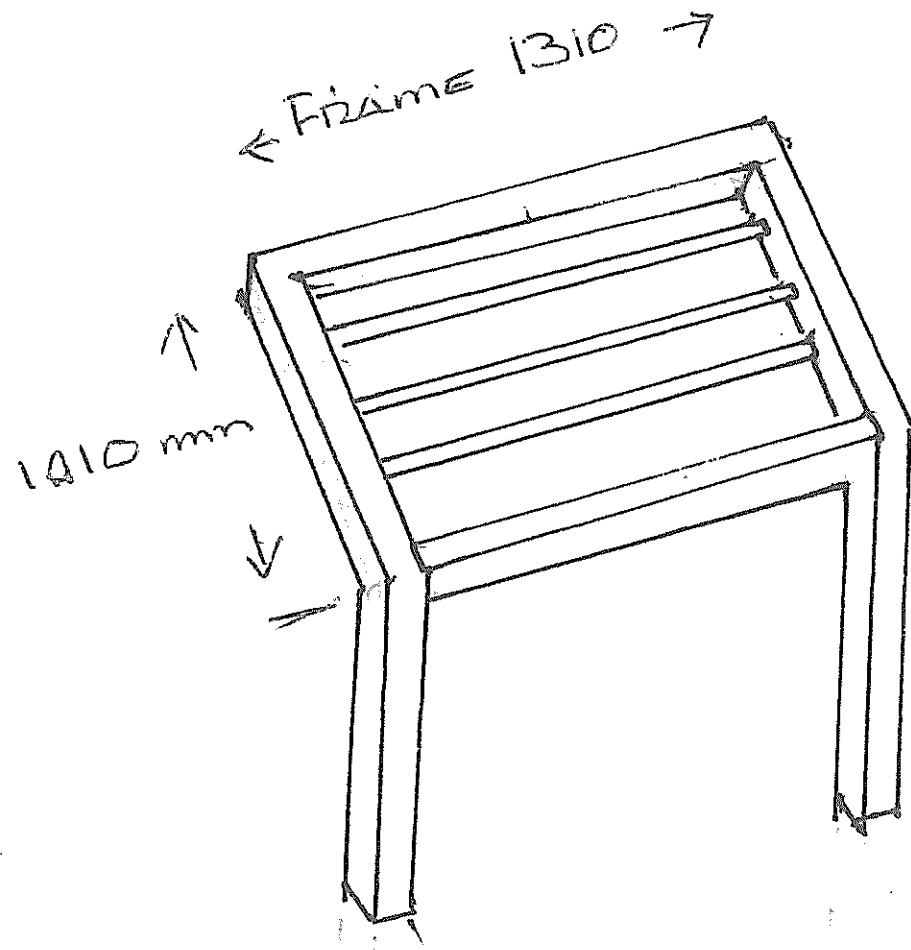

50mm RHS 2mm WALLS
3mm FLAT SUPPORTS

600mm IN GROUND

DONATION FORM

I/We are the owners of the items described below, and I/We hereby allow the copying of the listed items for historical retention and public access purposes.

I/We acknowledge that the donation as such will result in a digital copy of the item/s being held by the Dublin History Group Inc and the Mallala Museum (Mallala & Districts Historical Committee), with all rights and powers to do with the said item/s as each organisation sees fit. This may include printing, display, inclusion in publication/s and disposal.

The donation made by me/us will take effect at the time the Dublin History Group Inc and the Mallala Museum takes actual control of the items.

Name of Donor:.....

Address of Donor:.....

.....

Email address.....

Signature:.....

ITEM/S

.....
.....
.....
.....
.....
.....
.....
.....
.....
.....
.....
.....
.....
.....
.....
.....
.....
.....
.....
.....
.....

Item/s copied on 15 September 2019
at the Unveiling of the Historical Plaque for the Shannon Methodist Church and Cemetery



Dublin Community Projects

Founded August 2014

2019 Raffle

1400 Tickets at \$1-00 each

Drawn November 8th
Pt Parham Social Club at 7.30pm

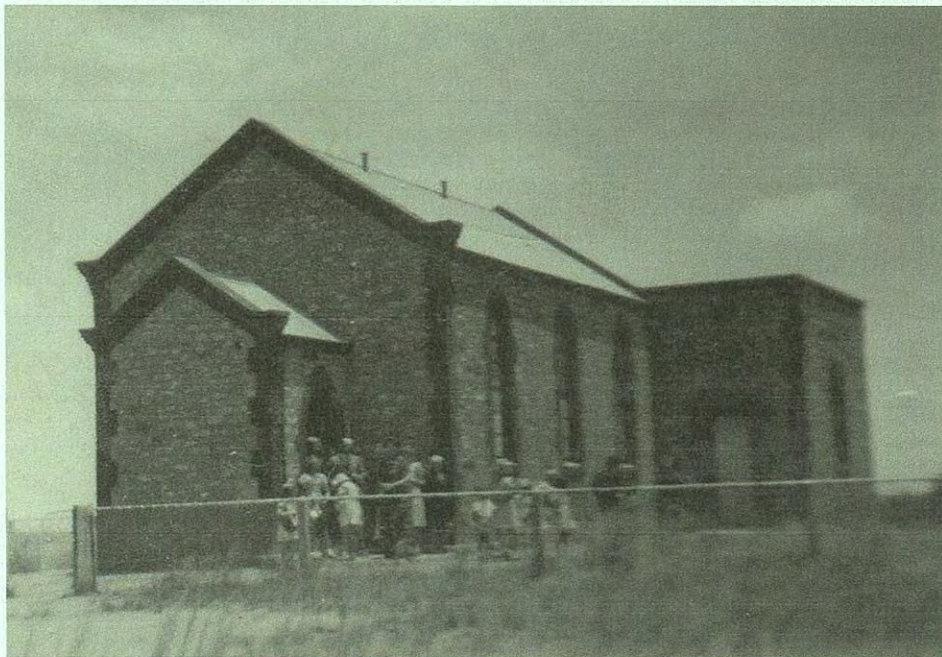

Current Project

Raising funds for a historical plaque providing the history of the former Shannon Methodist Church and Cemetery.

Unveiling Ceremony 15/9/2019 at 2-30 pm

All welcome

How finance is Raised

Izmir Tomato

Medium sized, smooth skinned,
heavy bearer, virus free tomatoes

\$2-00 per plant

Pickles and Marmalade

Mustard Pickles

Tomato Chutney

Tomato Relish

Marmalade

Various Prices

Cushions

Large \$17-80

Medium \$15-50

All money raised on this stall assists

Dublin Community Projects



Item/s copied on 15 September 2019
at the Unveiling of the Historical Plaque for the Shannon Methodist Church and Cemetery

Dublin Community Projects

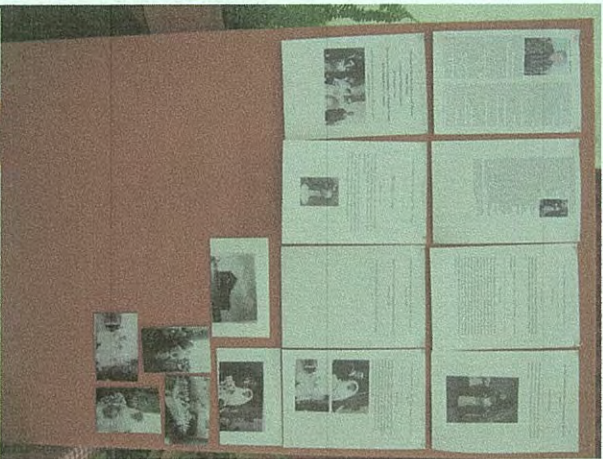



ON THIS DAY:



August 14, 1965, Sonny & Cher's hit song, "I got you back topped the billboard hot 100"

COMMUNITY NEWS BITES AND WHISPERS FROM AROUND THE REGION

Take 5 WITH LOUISE MICHAEL
EMAIL: louise@plainsproducer.com.au

All will be unveiled at Shannon

SHANNON
INSTIGATED by Dublin Community Projects, an historical plaque providing the history of the former Shannon Methodist Church and cemetery will be unveiled on Sunday, September 15.
The unveiling will be done by Beryl Wilson (nee Rowe) who was married in the church and Chris Jenkin, a volunteer who has family connections to the cemetery.
The church was opened back in 1873 in the Hundred of Dublin, with various additions made over the years.
In 1957, the church closed due to dwindling numbers and in 1966, fearing the church would be vandalised, the trustees agreed to have it demolished!
A cairn was built at the church site in 1977 and a time capsule inserted. Local Allan Parker planted some native trees on the church grounds in 1979, and will also be one of four people to plant a new tree at next month's dedication.
Others to plant a tree will be APC mayor Mark Wasley, Rev Dr Phil and Fraser Ellis.



ABOVE: Jean Rowe, second daughter of Mr & Mrs WD Rowe of Galomba marrying Private Kenneth McCallum at Shannon Methodist Church on May 5, 1945. They are Margaret March of Balaklava's parents. RIGHT: The former Shannon Methodist church in 1898.

Hands up if you went to primary school 'back in the day'. If so, do you have any information or stories you can share with the current owners of the property, which is now a heritage site? I'm guessing Ro Woo

In September 2018, a cemetery plot map board was initiated by Dublin Community Projects and installed by Adelaide Plains Council. Ian Telfer will be MC at the dedication service, and Rev Dr Phil Marshall will lead the dedication. The Parham Singers will also be singing a hymn during the dedication service.
Delicious afternoon tea will then be provided by Long Plains Red Cross.
RSVP for catering is required by September 7 to Pat Thompson on 8529 2028.

SALA
• **Balaklava:** The Courthouse Gallery is again involved in the SALA festival with the Balco Art Prize exhibition still on show until Sunday, September 1 – Father's Day!
Go and check out the wonderful art works on display (which are for sale) and perhaps pick up a SALA program and visit some of the other small galleries around.
The gallery is open Thursday, Friday and Sunday from 2-4pm, and entry is free.
• **Riverton:** Light Gallery is also open for the SALA festival, and is having a special performance this Sunday at 1pm.

The Vocal Chamber Chorus 'Acapella 'Vocali' will perform, and then you can enjoy a talk and display of works by artists Robert Hannaford and Alison Mitchell.
The inaugural recipient of the AME Bale Award (1969), Robert Hannaford asked homeless man Hans Krefel to sit for him, and this exhibition documents that extraordinary process.
Alison's array of small paintings of quiet times will allow you to reflect on life.
Their exhibition is open every weekend in August.



CORNY CORNER
* Did anybody see the movie about the hotdog.
It was an Oscar winner

Dear Diary: I tried running today. I am as swift as a gazelle. An old one... With Arthritis... R

Item/s copied on 15 September 2019
at the Unveiling of the Historical Plaque for the Shannon Methodist Church and Cemetery

Dublin Community Projects



history associated with Shannon. At this time the District Council of Mallala took over management of the Shannon Cemetery.

1977 A cairn was built on the site of the Shannon Methodist Church and on 17 April, the plaque was unveiled by Mr Frank Johnson. A time capsule was inserted into the cairn at its unveiling.

1984 Mr Allan Parker organised the planting of native trees by the Mallala Greening group and volunteers both on the church grounds and the eastern boundary.

2005 The *Shannon Cemetery* sign was built and erected by Basset Welding and Fabrication, Lewiston.

2010 Due to the popularity of cremations over burials, a columbarium was erected on the northern boundary to cater for this demand. The Rev. Grant Jewell officiated at the dedication ceremony on 11 April and Mrs Gwen Secomb OAM was the master of ceremonies. The Mallala Lions Club then donated a seat opposite the columbarium.

2018 A cemetery plot map board, initiated by Dublin Community Projects, was installed by the Adelaide Plains Council.

2019 A historical plaque today unveiled by Mrs Beryl Wilson and Mr Chris Jenkin. Robert Bushell laid the foundation for the plaque made by Original Signs of Lower Light. The plaque was financed by the community through Dublin Community Projects under the umbrella of the Adelaide Plains Council.

SHANNON METHODIST CHURCH AND CEMETERY

DEDICATION AND UNVEILING OF HISTORICAL PLAQUE

15 September 2019



ACKNOWLEDGEMENTS

Parham Singers.

Long Plains Red Cross for providing the delicious afternoon tea.

Adelaide Plains Council staff, especially Allison Down, Bradley Norman, Tom Jones and Kirk Daniel, for their assistance and support.

Max Jaeger of Original Signs for designing and making the plaque.

Robert Bushell for securing the historical plaque in concrete.

Louise Michael, Editor, Plains Producer for publicity and support.

Lisa Philip-Harbutt and Bill Field for copying photographs.

Thankyou to everyone for joining
the Dublin Community Projects Committee today.

Anthea Ailmore, Chris Jenkin, Jan and Ian Telfer,
Pat Thompson and Gwen Secomb OAM

PROGRAMME

Welcome by Mr Ian Telfer

Service conducted by Rev. Dr. Phillip Marshall

Address by Mr Fraser Ellis MP, Member for Narungga

Hymn led by Parham Singers

Address by Mr Mark Wasley, Mayor, Adelaide Plains Council

Unveiling of the plaque by
Mrs Beryl Wilson and Mr Chris Jenkin

Afternoon tea will be served in the Long Plains Memorial Hall

Please join the Parham Singers in singing the hymn

All Things Bright And Beautiful

*All things bright and beautiful
All creatures great and small
All things wise and wonderful
The Lord God made them all.*

*Each little flower that opens
Each little bird that sings
He made their glowing colours
He made their tiny wings*

Chorus: All things bright and beautiful...

*He gave us eyes to see them
And lips that we might tell
How great is God Almighty
Who has made all things well.
Chorus: All things bright and beautiful...*

The Lords Prayer

Our Father which art in heaven
Hallowed be thy Name
Thy kingdom come, Thy will be done,
on earth as it is in heaven
Give us this day our daily bread
And forgive us our trespasses
As we forgive those who trespass against us
And lead us not into temptation
But deliver us from evil
For thine is the kingdom,
The power and the glory
For ever and ever. Amen

Shannon Methodist Church and Cemetery

1873 to 1966

The foundation stone of the Shannon Methodist Chapel in the name of God the Father, Son and the Holy Spirit, by Joshua Marshman of Mallala on the 8th day of October, year of our Lord one thousand eight hundred and seventy two (1872) being the thirty sixth year of her most gracious Majesty Queen Victoria, his Excellency the Right Honourable Sir James Wayland being the Governor of the Province of South Australia, the Rev. James Stewart Wayland and Steven James Nicholls being ministers of the circuit, Mr Henry Nicholls being the circuit steward, and Charles Bruce Carslake, Robert Cooper, James Davis, Steven Davis, George Nicholas Johnson, Noble Johnson Weatherall-Lindsay and John Thomas Sutton being the trustees of the chapel. May God bless this undertaking. John Wayland 8th October 1872.

1873 The Primitive Methodist Church was officially opened on 17 July by Joshua Marshman of Mallala on land donated by the Wright brothers in an area known as thirty mile scrub in the Hundred of Dublin. Previously, worship was held in the homes of Messrs Johnson and Baker. Specifications of the building were completed by Rev. J. S. Wayland. The church, constructed of local stone with six gothic windows and a porch, was built by Jonathon Porter, the woodwork by Mr Joseph Smith and the furnishings made by Mr Uffindale. It had a capacity of 140 people.

1901 The church joined the Methodist Union

1908 A T-shaped addition to the western wall was built by Mr Burton to accommodate the Sunday School.

1922 The land on the eastern boundary was purchased from the Rowe family for a nominal figure, to create the triangle shape it is today.

1923 Mr Hartley was elected curator of the cemetery adjacent to the church. The Jubilee of the Shannon Methodist Church was held over several days and on Sunday 23 July, two services were held with Rev. A.W. Wellington officiating.

1957 Due to declining numbers attending, the church was closed.

1966 Fearing the church would be vandalised, the trustees agreed to its demolition. The demolition was done by with the greatest of care by Messrs Ira, Mervin and Neville Jenkin, as it was understood that a bottle containing items of historical importance was held in the building. The bottle was eventually found where the church porch and the church walls met. Mr Mervin Jenkin took the bottle to the Long Plains school the next day and told the children about the

history associated with Shannon. At this time the District Council of Mallala took over management of the Shannon Cemetery.

1977 A cairn was built on the site of the Shannon Methodist Church and on 17 April, the plaque was unveiled by Mr Frank Johnson. A time capsule was inserted into the cairn at its unveiling.

1984 Mr Allan Parker organised the planting of native trees by the Mallala Greening group and volunteers both on the church grounds and the eastern boundary.

2005 The *Shannon Cemetery* sign was built and erected by Basset Welding and Fabrication, Lewiston.

2010 Due to the popularity of cremations over burials, a columbarium was erected on the northern boundary to cater for this demand. The Rev. Grant Jewell officiated at the dedication ceremony on 11 April and Mrs Gwen Secomb OAM was the master of ceremonies. The Mallala Lions Club then donated a seat opposite the columbarium.

2018 A cemetery plot map board, initiated by Dublin Community Projects, was installed by the Adelaide Plains Council.

2019 A historical plaque today unveiled by Mrs Beryl Wilson and Mr Chris Jenkin. Robert Bushell laid the foundation for the plaque made by Original Signs of Lower Light. The plaque was financed by the community through Dublin Community Projects under the umbrella of the Adelaide Plains Council.

SHANNON METHODIST CHURCH AND CEMETERY

DEDICATION AND UNVEILING OF HISTORICAL PLAQUE

15 September 2019



ACKNOWLEDGEMENTS

Parham Singers.

Long Plains Red Cross for providing the delicious afternoon tea.

Adelaide Plains Council staff, especially Allison Down, Bradley Norman, Tom Jones and Kirk Daniel, for their assistance and support.

Max Jaeger of Original Signs for designing and making the plaque.

Robert Bushell for securing the historical plaque in concrete.

Louise Michael, Editor, Plains Producer for publicity and support.

Lisa Philip-Harbutt and Bill Field for copying photographs.

Thankyou to everyone for joining
the Dublin Community Projects Committee today.

Anthea Ailmore, Chris Jenkin, Jan and Ian Telfer,
Pat Thompson and Gwen Secomb OAM

PROGRAMME

Welcome by Mr Ian Telfer

Service conducted by Rev. Dr. Phillip Marshall

Address by Mr Fraser Ellis MP, Member for Narungga

Hymn led by Parham Singers

Address by Mr Mark Wasley, Mayor, Adelaide Plains Council

Unveiling of the plaque by
Mrs Beryl Wilson and Mr Chris Jenkin

Afternoon tea will be served in the Long Plains Memorial Hall

Please join the Parham Singers in singing the hymn

All Things Bright And Beautiful

*All things bright and beautiful
All creatures great and small
All things wise and wonderful
The Lord God made them all.*

*Each little flower that opens
Each little bird that sings
He made their glowing colours
He made their tiny wings*

Chorus: All things bright and beautiful...

*He gave us eyes to see them
And lips that we might tell
How great is God Almighty
Who has made all things well.
Chorus: All things bright and beautiful...*

The Lords Prayer

Our Father which art in heaven
Hallowed be thy Name
Thy kingdom come, Thy will be done,
on earth as it is in heaven
Give us this day our daily bread
And forgive us our trespasses
As we forgive those who trespass against us
And lead us not into temptation
But deliver us from evil
For thine is the kingdom,
The power and the glory
For ever and ever. Amen

Shannon Methodist Church and Cemetery

1873 to 1966

The foundation stone of the Shannon Methodist Chapel in the name of God the Father, Son and the Holy Spirit, by Joshua Marshman of Mallala on the 8th day of October, year of our Lord one thousand eight hundred and seventy two (1872) being the thirty sixth year of her most gracious Majesty Queen Victoria, his Excellency the Right Honourable Sir James Wayland being the Governor of the Province of South Australia, the Rev. James Stewart Wayland and Steven James Nicholls being ministers of the circuit, Mr Henry Nicholls being the circuit steward, and Charles Bruce Carslake, Robert Cooper, James Davis, Steven Davis, George Nicholas Johnson, Noble Johnson Weatherall-Lindsay and John Thomas Sutton being the trustees of the chapel. May God bless this undertaking. John Wayland 8th October 1872.

1873 The Primitive Methodist Church was officially opened on 17 July by Joshua Marshman of Mallala on land donated by the Wright brothers in an area known as thirty mile scrub in the Hundred of Dublin. Previously, worship was held in the homes of Messrs Johnson and Baker. Specifications of the building were completed by Rev. J. S. Wayland. The church, constructed of local stone with six gothic windows and a porch, was built by Jonathon Porter, the woodwork by Mr Joseph Smith and the furnishings made by Mr Uffindale. It had a capacity of 140 people.

1901 The church joined the Methodist Union

1908 A T-shaped addition to the western wall was built by Mr Burton to accommodate the Sunday School.

1922 The land on the eastern boundary was purchased from the Rowe family for a nominal figure, to create the triangle shape it is today.

1923 Mr Hartley was elected curator of the cemetery adjacent to the church. The Jubilee of the Shannon Methodist Church was held over several days and on Sunday 23 July, two services were held with Rev. A.W. Wellington officiating.

1957 Due to declining numbers attending, the church was closed.

1966 Fearing the church would be vandalised, the trustees agreed to its demolition. The demolition was done by with the greatest of care by Messrs Ira, Mervin and Neville Jenkin, as it was understood that a bottle containing items of historical importance was held in the building. The bottle was eventually found where the church porch and the church walls met. Mr Mervin Jenkin took the bottle to the Long Plains school the next day and told the children about the

From: Pat Thompson <pattandsidf@gmail.com>
Sent: Friday, 15 November 2019 12:24 PM
To: Anne Sawtell
Cc: Ailmore Transport; Gwen Secomb; Chris Jenkin; Ian Telfer
Subject: Australia Day Award nomination - corrected version
Attachments: Shannon Programme.pdf

Brief details for the planning and dedication of the former Shannon Methodist Church and Cemetery Historical Plaque 15th September 2019-11-14 that took several years to materialise

Arranged and funded by Dublin Community Project members ---Anthea Ailmore, Ian Telfer, Pat Thompson and for this project only were joined by Chris Jenkin and Gwen Secomb Meetings were held regularly for several months in the cafe of the Dublin General Store.

Lower Light's sign writer Max Jaeger of Original Signs designed and made the historical plaque for a cost of \$17500.

Monies were raised to finance the plaque through the sale of jams, pickles. plants . Christmas Lolly Trees, a raffle , cushions, babies patchwork cot covers/floor rugs etc.

Local Dublin business's together with the Pt Parham Sports and Social Club Inc. committee support Dublin Community Projects by selling items and produce that assists greatly with the raising of finance.

The support received from council senior staff members, Alison Down and Tom Jones who were both most helpful with their advice re the plaque design, together with Bradley Norman who kindly donated four trees together with tree guards that Fraser Ellis M,P. . Mayor Mark Wasley, Rev.Dr Philip Marshal and Allan Parker planted .at the end of the joint plaque unveiling by Mrs Beryl Wilson (who was married in the Shannon Church in the early 1940's) and Mr Chris Jenkin (who for many years now has voluntarily kept a watchful eye on the Shannon Cemetery) was greatly appreciated

The Mallala Museum committee kindly lent the original Shannon Church front door for this special occasion. Long Plains Red Cross members catered with a delicious afternoon tea in the Long Plains Memorial Hall. for the one hundred plus people who attended. A gold coin donation was requested on each invitation.

Many photographs were bought along for Bill Field to copy that both the Dublin History Group Inc, and Mallala Museum committee with receive copies of, as they also will of all photographs taken on the day . Gwen Secomb has taken on the responsibility of co-ordinating all information/ photographs received on the day for both organisations

There has been a large amount of positive feedback received over these past weeks from a number of former residents who attended –some travelling from interstate and far off SA country towns..

Thank you for reading my brief account of the 15th September 2019-11-15

On behalf of Anthea Ailmore, Gwen Secomb, Chris Jenkin, Ian Telfer

Regards Pat Thompson

Dublin Community Projects

Nomination Form:



**Adelaide
Plains
Council**

Nominee (the person/organisation you would like to nominate)

Please provide as much information as possible. Additional documents may be attached providing further information or testimonials of achievement.

Award Category (please tick)

- CITIZEN
- YOUNG CITIZEN
- COMMUNITY EVENT
- COMMUNITY PROJECT
- COMMUNITY GROUP

Name: Two Wells Melodrama Group Inc.

Address: [Redacted]

Phone: [Redacted]

Date of Birth: [Redacted]

Email: [Redacted]

Is the person being nominated an Australian citizen? YES NO N/A.

Reason for nomination

How has the person/organisation contributed to the community?

Refer attachment.

Please list any other significant contributions and/or achievements:

Refer attachment.

Additional material may be attached: maximum five A4 pages, minimum font size 10 point.

Nominator (your details)

Name: [Redacted]

Address: [Redacted]

Phone: [Redacted]

Email: [Redacted]

I give permission for the Australia Day Council of South Australia to submit this nomination to other recognition programs such as the Australian of the Year Awards.

Please return completed form before Friday 15 November 2019 to:

Anne Sawtell, Library and Community Services Manager, Adelaide Plains Council, PO Box 18, MALLALA SA 5502
Or email info@apc.sa.gov.au

For further information please contact the Manager Library and Community Services on 8527 0200.

Nomination for Community group of the year 2019

TWO WELLS MELODRAMA GROUP

Two Wells Melodrama Group has, since it began in 1982, raised more than \$700,000 through its annual amateur theatre productions.

These funds have been ploughed back into the Two Wells and surrounding community, with a significant amount of \$392,000 going to the Two Wells Community Centre (formerly Two Wells Institute Committee) for providing catering and liquor licensed facilities for patrons.

In the Community Centre's early days, the annual Melodrama was the Centre's principal source of income, enabling the Community Centre to repay in full a ten-year debenture loan, provided through the then Mallala Council to construct the building.

Later, the income from the Melodrama helped the Community Centre committee extend the building by enlarging the kitchen, and creating a backstage area and meeting room.

The Melodrama Group also donates a portion of ticket sales proceeds to a number of local organisations that provide volunteers to help with the massive task of catering three- and two-course meals for more than 800 people who attend the show each year.

In 2019, almost \$8,000 was donated to these local organisations through sales of tickets in the name of each organisation.

More than \$2,000 extra was raised through raffle ticket sales at each of the six performances, and this was donated to Adelaide Plains Crossroad Connections Suicide Prevention Network.

The Melodrama Group is entirely run by volunteers, with more than 100 involved at each of its six performances every year.

Some have volunteered their professional technical skills to improve the technical facilities available at the Centre.

Young people from within the community are encouraged to help with front of house duties, by seating patrons as they arrive at the venue, and serving meals.

For some, their front of house experience has led to their joining the Melodrama Group and becoming involved in the actual production, while others have been given good references towards future employment opportunities.

Experience with the Melodrama Group has led several members to follow careers in the media, arts and entertainment fields; notably as stage managers, performers with other theatre groups and radio announcers.

Most of the group's shows are original, having been written by members, generally with advanced senses of the ridiculous.

Two Wells Melodrama Group is an outstanding and unique enterprise.

For nearly 40 years it has been supporting local community and sporting groups, as well as providing a creative outlet for those who pass through its ranks.

Nomination Form:



Adelaide Plains Council

Adelaide Plains Council
RECEIVED
15 NOV 2019

Nominee (the person/organisation you would like to nominate)

Please provide as much information as possible. Additional documents may be attached providing further information or testimonials of achievement.

Award Category (please tick)

- CITIZEN
- YOUNG CITIZEN
- COMMUNITY EVENT
- COMMUNITY PROJECT
- COMMUNITY GROUP

Name: *Dublin Community Projects: former Shannon Church and Cemetery Historical Plaque Unveiling 15-9-2019.*
 [Redacted]
 Phone: [Redacted]
 Email: [Redacted]

Is the person a citizen? YES NO

Reason for nomination

How has the person/organisation contributed to the community?

This project was several years in the planning. Chris Jenkin whose father assisted with the demolition of the Church was a wonderful source of details. Gwion Secombe was also very helpful. The unveiling was attended by in excess of 100 people. Long Plains Red Cross members catered for afternoon tea.

Please list any other significant contributions and/or achievements:
restoration of Dublin Cemetery Gates and fund a new front fence and 2 seats. installed. Blinds in Windsor Institute.

Additional material may be attached: maximum five A4 pages, minimum font size 10 point.

Nominator (your details)

Name: [Redacted]
 Address: [Redacted]
 [Redacted]
 Email: [Redacted]

I give permission for the Australia Day Council of South Australia to submit this nomination to other recognition programs such as the Australian of the Year Awards.

Please return completed form before Friday 15 November 2019 to:

Anne Sawtell, Library and Community Services Manager, Adelaide Plains Council, PO Box 18, MALLALA SA 5502
Or email info@apc.sa.gov.au

For further information please contact the Manager Library and Community Services on 8527 0200.

[REDACTED]

[REDACTED]

[REDACTED]

[REDACTED]

[REDACTED]

[REDACTED]

[REDACTED]

[REDACTED]

[REDACTED]

[REDACTED]

[REDACTED]

[REDACTED]

[REDACTED]

Dublin Community Projects



The committee invites



To attend the Unveiling of a plaque
providing the history of the
Shannon Methodist Church and Cemetery at Calomba
by Mrs Beryl Wilson and Mr Chris Jenkin
on **Sunday 15th September 2019 at 2:30 pm**

To assist with seating, please bring a chair.

Afternoon tea will be provided by the Long Plains Red Cross members
after the ceremony in the Long Plains Soldiers Memorial Hall
(gold coin donation)

RSVP by 7th September to Pat Thompson
Ph. 8529 2028 or DublinCommunityProjects@gmail.com

To assist with collecting our local history, it would be appreciated if any photos or documents relating to people, businesses, events and buildings in the Calomba, Dublin, Long Plain, Lower Light, Shannon, Wild Horse Plains and Windsor districts, as well as the coastal area from Parham to Port Prime. Copying facilities will be available on the day.

Shannon brought back to life

Louise Michael reports:

SHANNON was brought to life on Sunday, September 15 as a large crowd gathered for the official opening of an impressive plaque providing the history of the former Shannon Methodist church and cemetery.

MC Ian Telfer welcomed everyone, including descendants of former residents, before Adelaide Plains Council mayor, Mark Wasley, Fraser Ellis MP, and Rev Dr Phillip Marshall gave short speeches, before the plaque with history from 1873 to 1966, was unveiled by Beryl Wilson and Chris Jenkin.

The plaque was instigated by Dublin Community Projects. Rev Dr Phil, Mr Ellis and Mr Wasley then each planted a tree in the cemetery grounds after the dedication.

Parham Singers led the singing of the hymn, All Things Bright and Beautiful, sung with gusto!

After the ceremony, everyone went to the Long Plains hall to browse through displays of old photos and memorabilia. One item of interest was the original front door of the Shannon Church, lent for the day by Mallala Museum.

Bill Field was on hand to scan photos for people, with copies also made for the Mallala Museum and Dublin History Group. A delicious afternoon tea, provided by the Long Plains Red Cross, was enjoyed by everyone.



Chris Jenkin helps Beryl Wilson unveil the new plaque.



Margaret March, Beryl Wilson (nee Rowe) and Ruth Symons. Margaret was flowergirl in Beryl's wedding, and Beryl is the only surviving Rowe family member who was married in the church.



Chris Jenkin and Allan Parker planting a tree.



The history plaque.



Nita Noble, Gwenda Griffiths and Lois Wasley.



Ellen Gilbert and Lois Williams-Pinchbeck.

Mackenzie Homes & Commercial pty Ltd

**CUSTOM BUILT HOMES
ADDITIONS AND
RENOVATIONS**



HIA GreenSmart PROFESSIONAL
'Greensmart Energy Efficiency'



Pat Thompson and Gwen Secomb looking at photos pinned on the original door of the Shannon Methodist Church.



Max and Ruth Symons, Beryl Wilson, Milton and Ruth Rowe.

BOLTS ON SALE



NO, NOT THOSE! **THESE!**

25% OFF
WHEN YOU BUY

SHANNON METHODIST CHURCH

1873 - 1966

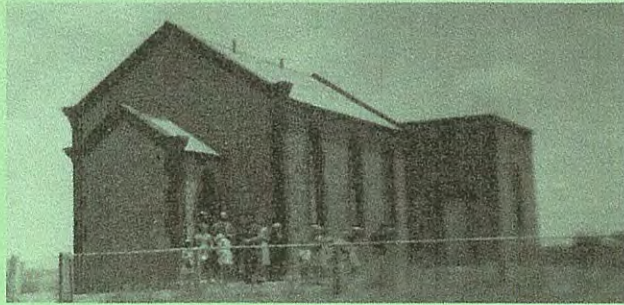

The following was documented on the church's original history. The foundation stone of the Shannon Methodist Chapel in the name of God the Father, Son and the Holy Spirit, by Joshua Marshman of Mallala on the 8th day of October year of our Lord. One Thousand eight hundred and seventy two [1872] being the thirty sixth year of her most gracious Majesty Queen Victoria His Excellency the Right Honourable Sir James Wayland being the Governor of the Province of South Australia, the Rev. James Stewart Wayland and Steven James Nicholls being ministers of the circuit, Mr Henry Nicholls being the circuit steward, and Charles Bruce Carslake, Robert Cooper, James Davis, Steven Davis, George Nicholas Johnson, Noble Johnson Weatherall-Lindsay and John Thomas Sutton being the trustees of the chapel. May God bless this undertaking John Wayland 8th October 1872.



1873 - The Primitive Methodist Church was officially opened on 17th July by Joshua Marshman of Mallala on land donated by the Wright brothers in an area known as 30 mile scrub in the hundred of Dublin. Previously, worship was held in homes of Messrs Johnson and Baker. Specifications of the building were completed by Rev. J. S. Wayland. The church, was constructed of local stone with six gothic windows and a porch, was built by Mr Johnathon Porter, the woodwork by Mr Joseph Smith and the furnishings made by Mr Uffindale. It had a capacity of 140 people.



1901 - The church joined the Methodist Union.



1908 - A T shaped addition to the western wall was built by Mr T Burton to accommodate the Sunday School.



1922 - The land on the eastern boundary was purchased from the Roy family for a nominal figure, to create the triangle shape it is today.



1923 - Mr Hartley was elected curator of the cemetery adjacent to the church. The Jubilee of the Shannon Methodist Church was held over several days and on Sunday 23rd July two services were held with Rev. A.W. Welli.



1957 - Due to declining numbers attending, the church was closed.



1966 - Fearing the church would be vandalised, the trustees agreed to demolish the church. The demolition was done with the greatest of care, by Messrs Ira, Mervin & Neville Jenkin, as it was understood that a bottle containing items of historical importance was held in the building. The bottle was eventually found where the porch and the church walls met. Mr Mervin Jenkin took the bottle to the Long Plains school the next day and told the children about the history associated with Shannon. At the time the District Council of Mallala took over management of the Shannon Cemetery.



1977 - A cairn was built on the site of the Shannon Methodist Church and on April 17th 1977, the plaque was unveiled by Mr Frank Johnson. A time capsule was inserted into the cairn at its unveiling.



1984 - Mr Allan Parker organised the planting of native trees by the Mallala Greening Group members and volunteers both on church grounds and along the eastern boundary.



2005 - The "Shannon Cemetery" sign was built and erected by Basset Welding & Fabrication, Lewiston.



2010 - Due to the popularity of cremations over burials, a columbarium was erected on the northern boundary to cater for this demand. The Rev. Jewell officiated at the dedication ceremony on the 11th April and Mr M Secomb OAM was the master of ceremonies. Later that year, the Mallala Club donated a seat opposite the columbarium.



2018 - Cemetery plot map board initiated by Dublin Community Project and installed by Adelaide Plains Council.



2019 - This plaque was jointly unveiled on 15 Sept. 2019 by Mrs Beryl and Mr Chris Jenkin. Robert Bushell laid the foundation for the plaque by Original Signs. The plaque was financed by the community through Community Projects under the umbrella of the Adelaide Plains Council.



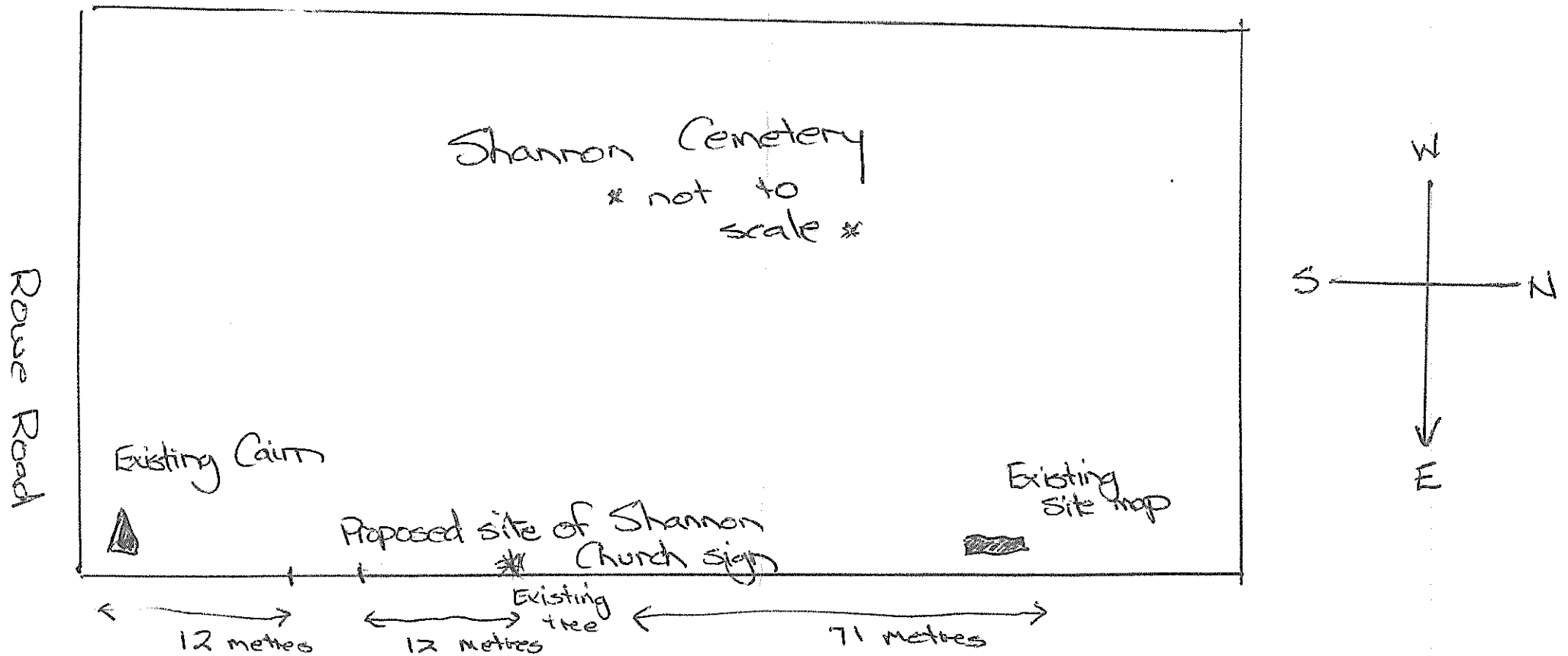

Height of existing fence
900mm.

history associated with Shannon. At this time the District Council of Mallala took over management of the Shannon Cemetery.

1977 A cairn was built on the site of the Shannon Methodist Church and on 17 April, the plaque was unveiled by Mr Frank Johnson. A time capsule was inserted into the cairn at its unveiling.

1984 Mr Allan Parker organised the planting of native trees by the Mallala Greening group and volunteers both on the church grounds and the eastern boundary.

2005 The *Shannon Cemetery* sign was built and erected by Basset Welding and Fabrication, Lewiston.

2010 Due to the popularity of cremations over burials, a columbarium was erected on the northern boundary to cater for this demand. The Rev. Grant Jewell officiated at the dedication ceremony on 11 April and Mrs Gwen Secomb OAM was the master of ceremonies. The Mallala Lions Club then donated a seat opposite the columbarium.

2018 A cemetery plot map board, initiated by Dublin Community Projects, was installed by the Adelaide Plains Council.

2019 A historical plaque today unveiled by Mrs Beryl Wilson and Mr Chris Jenkin. Robert Bushell laid the foundation for the plaque made by Original Signs of Lower Light. The plaque was financed by the community through Dublin Community Projects under the umbrella of the Adelaide Plains Council.

SHANNON METHODIST CHURCH AND CEMETERY

DEDICATION AND UNVEILING OF HISTORICAL PLAQUE

15 September 2019



ACKNOWLEDGEMENTS

Parham Singers.

Long Plains Red Cross for providing the delicious afternoon tea.

Adelaide Plains Council staff, especially Allison Down, Bradley Norman, Tom Jones and Kirk Daniel, for their assistance and support.

Max Jaeger of Original Signs for designing and making the plaque.

Robert Bushell for securing the historical plaque in concrete.

Louise Michael, Editor, Plains Producer for publicity and support.

Lisa Philip-Harbutt and Bill Field for copying photographs.

Thankyou to everyone for joining
the Dublin Community Projects Committee today.

Anthea Ailmore, Chris Jenkin, Jan and Ian Telfer,
Pat Thompson and Gwen Secomb OAM

PROGRAMME

Welcome by Mr Ian Telfer

Service conducted by Rev. Dr. Phillip Marshall

Address by Mr Fraser Ellis MP, Member for Narungga

Hymn led by Parham Singers

Address by Mr Mark Wasley, Mayor, Adelaide Plains Council

Unveiling of the plaque by
Mrs Beryl Wilson and Mr Chris Jenkin

Afternoon tea will be served in the Long Plains Memorial Hall

Please join the Parham Singers in singing the hymn

All Things Bright And Beautiful

*All things bright and beautiful
All creatures great and small
All things wise and wonderful
The Lord God made them all.*

*Each little flower that opens
Each little bird that sings
He made their glowing colours
He made their tiny wings*

Chorus: All things bright and beautiful...

*He gave us eyes to see them
And lips that we might tell
How great is God Almighty
Who has made all things well.
Chorus: All things bright and beautiful...*

The Lords Prayer

Our Father which art in heaven
Hallowed be thy Name
Thy kingdom come, Thy will be done,
on earth as it is in heaven
Give us this day our daily bread
And forgive us our trespasses
As we forgive those who trespass against us
And lead us not into temptation
But deliver us from evil
For thine is the kingdom,
The power and the glory
For ever and ever. Amen

Shannon Methodist Church and Cemetery

1873 to 1966

The foundation stone of the Shannon Methodist Chapel in the name of God the Father, Son and the Holy Spirit, by Joshua Marshman of Mallala on the 8th day of October, year of our Lord one thousand eight hundred and seventy two (1872) being the thirty sixth year of her most gracious Majesty Queen Victoria, his Excellency the Right Honourable Sir James Wayland being the Governor of the Province of South Australia, the Rev. James Stewart Wayland and Steven James Nicholls being ministers of the circuit, Mr Henry Nicholls being the circuit steward, and Charles Bruce Carslake, Robert Cooper, James Davis, Steven Davis, George Nicholas Johnson, Noble Johnson Weatherall-Lindsay and John Thomas Sutton being the trustees of the chapel. May God bless this undertaking. John Wayland 8th October 1872.

1873 The Primitive Methodist Church was officially opened on 17 July by Joshua Marshman of Mallala on land donated by the Wright brothers in an area known as thirty mile scrub in the Hundred of Dublin. Previously, worship was held in the homes of Messrs Johnson and Baker. Specifications of the building were completed by Rev. J. S. Wayland. The church, constructed of local stone with six gothic windows and a porch, was built by Jonathon Porter, the woodwork by Mr Joseph Smith and the furnishings made by Mr Uffindale. It had a capacity of 140 people.

1901 The church joined the Methodist Union

1908 A T-shaped addition to the western wall was built by Mr Burton to accommodate the Sunday School.

1922 The land on the eastern boundary was purchased from the Rowe family for a nominal figure, to create the triangle shape it is today.

1923 Mr Hartley was elected curator of the cemetery adjacent to the church. The Jubilee of the Shannon Methodist Church was held over several days and on Sunday 23 July, two services were held with Rev. A.W. Wellington officiating.

1957 Due to declining numbers attending, the church was closed.

1966 Fearing the church would be vandalised, the trustees agreed to its demolition. The demolition was done by with the greatest of care by Messrs Ira, Mervin and Neville Jenkin, as it was understood that a bottle containing items of historical importance was held in the building. The bottle was eventually found where the church porch and the church walls met. Mr Mervin Jenkin took the bottle to the Long Plains school the next day and told the children about the

SIGN TO FIT INSIDE FRAMEWORK

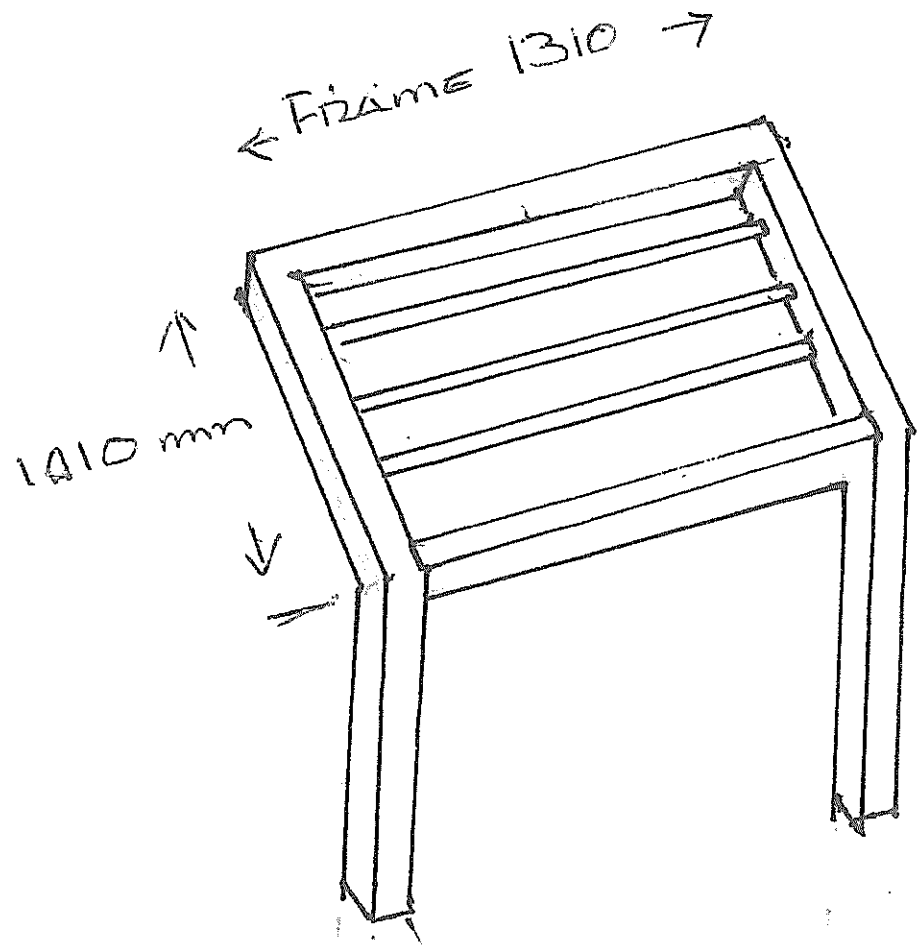

50mm RHS 2mm WALLS
3mm FLAT SUPPORTS

600mm IN GROUND

Dublin Community Projects

Founded August 2014

2019 Raffle

1400 Tickets at \$1-00 each

Drawn November 8th
Pt Parham Social Club at 7.30pm



Current Project

Raising funds for a historical plaque providing the history of the former Shannon Methodist Church and Cemetery.

Unveiling Ceremony 15/9/2019 at 2-30 pm

All welcome

How finance is raised.

Izmir Tomato

Medium sized, smooth skinned,
heavy bearer, virus free tomatoes

\$2-00 per plant

Pickles and Marmalade

Mustard Pickles

Tomato Chutney

Tomato Relish

Marmalade

Various Prices

Cushions

Large \$17-80

Medium \$15-50

All money raised on this stall assists

Dublin Community Projects

history associated with Shannon. At this time the District Council of Mallala took over management of the Shannon Cemetery.

1977 A cairn was built on the site of the Shannon Methodist Church and on 17 April, the plaque was unveiled by Mr Frank Johnson. A time capsule was inserted into the cairn at its unveiling.

1984 Mr Allan Parker organised the planting of native trees by the Mallala Greening group and volunteers both on the church grounds and the eastern boundary.

2005 The *Shannon Cemetery* sign was built and erected by Basset Welding and Fabrication, Lewiston.

2010 Due to the popularity of cremations over burials, a columbarium was erected on the northern boundary to cater for this demand. The Rev. Grant Jewell officiated at the dedication ceremony on 11 April and Mrs Gwen Secomb OAM was the master of ceremonies. The Mallala Lions Club then donated a seat opposite the columbarium.

2018 A cemetery plot map board, initiated by Dublin Community Projects, was installed by the Adelaide Plains Council.

2019 A historical plaque today unveiled by Mrs Beryl Wilson and Mr Chris Jenkin. Robert Bushell laid the foundation for the plaque made by Original Signs of Lower Light. The plaque was financed by the community through Dublin Community Projects under the umbrella of the Adelaide Plains Council.

SHANNON METHODIST CHURCH AND CEMETERY

DEDICATION AND UNVEILING OF HISTORICAL PLAQUE

15 September 2019



ACKNOWLEDGEMENTS

Parham Singers.

Long Plains Red Cross for providing the delicious afternoon tea.

Adelaide Plains Council staff, especially Allison Down, Bradley Norman, Tom Jones and Kirk Daniel, for their assistance and support.

Max Jaeger of Original Signs for designing and making the plaque.

Robert Bushell for securing the historical plaque in concrete.

Louise Michael, Editor, Plains Producer for publicity and support.

Lisa Philip-Harbutt and Bill Field for copying photographs.

Thankyou to everyone for joining
the Dublin Community Projects Committee today.

Anthea Ailmore, Chris Jenkin, Jan and Ian Telfer,
Pat Thompson and Gwen Secomb OAM

PROGRAMME

Welcome by Mr Ian Telfer

Service conducted by Rev. Dr. Phillip Marshall

Address by Mr Fraser Ellis MP, Member for Narungga

Hymn led by Parham Singers

Address by Mr Mark Wasley, Mayor, Adelaide Plains Council

Unveiling of the plaque by
Mrs Beryl Wilson and Mr Chris Jenkin

Afternoon tea will be served in the Long Plains Memorial Hall

Please join the Parham Singers in singing the hymn

All Things Bright And Beautiful

*All things bright and beautiful
All creatures great and small
All things wise and wonderful
The Lord God made them all.*

*Each little flower that opens
Each little bird that sings
He made their glowing colours
He made their tiny wings*

Chorus: All things bright and beautiful...

*He gave us eyes to see them
And lips that we might tell
How great is God Almighty
Who has made all things well.
Chorus: All things bright and beautiful...*

The Lords Prayer

Our Father which art in heaven
Hallowed be thy Name
Thy kingdom come, Thy will be done,
on earth as it is in heaven
Give us this day our daily bread
And forgive us our trespasses
As we forgive those who trespass against us
And lead us not into temptation
But deliver us from evil
For thine is the kingdom,
The power and the glory
For ever and ever. Amen

Shannon Methodist Church and Cemetery

1873 to 1966

The foundation stone of the Shannon Methodist Chapel in the name of God the Father, Son and the Holy Spirit, by Joshua Marshman of Mallala on the 8th day of October, year of our Lord one thousand eight hundred and seventy two (1872) being the thirty sixth year of her most gracious Majesty Queen Victoria, his Excellency the Right Honourable Sir James Wayland being the Governor of the Province of South Australia, the Rev. James Stewart Wayland and Steven James Nicholls being ministers of the circuit, Mr Henry Nicholls being the circuit steward, and Charles Bruce Carslake, Robert Cooper, James Davis, Steven Davis, George Nicholas Johnson, Noble Johnson Weatherall-Lindsay and John Thomas Sutton being the trustees of the chapel. May God bless this undertaking. John Wayland 8th October 1872.

1873 The Primitive Methodist Church was officially opened on 17 July by Joshua Marshman of Mallala on land donated by the Wright brothers in an area known as thirty mile scrub in the Hundred of Dublin. Previously, worship was held in the homes of Messrs Johnson and Baker. Specifications of the building were completed by Rev. J. S. Wayland. The church, constructed of local stone with six gothic windows and a porch, was built by Jonathon Porter, the woodwork by Mr Joseph Smith and the furnishings made by Mr Uffindale. It had a capacity of 140 people.

1901 The church joined the Methodist Union

1908 A T-shaped addition to the western wall was built by Mr Burton to accommodate the Sunday School.

1922 The land on the eastern boundary was purchased from the Rowe family for a nominal figure, to create the triangle shape it is today.

1923 Mr Hartley was elected curator of the cemetery adjacent to the church. The Jubilee of the Shannon Methodist Church was held over several days and on Sunday 23 July, two services were held with Rev. A.W. Wellington officiating.

1957 Due to declining numbers attending, the church was closed.

1966 Fearing the church would be vandalised, the trustees agreed to its demolition. The demolition was done by with the greatest of care by Messrs Ira, Mervin and Neville Jenkin, as it was understood that a bottle containing items of historical importance was held in the building. The bottle was eventually found where the church porch and the church walls met. Mr Mervin Jenkin took the bottle to the Long Plains school the next day and told the children about the



Item/s copied on 15 September 2019
at the Unveiling of the Historical Plaque for the Shannon Methodist Church and Cemetery

Dublin Community Projects



ON THIS DAY:



August 14, 1965, Sonny & Cher's hit song, "I got you b topped the billboard hot 10

COMMUNITY NEWS BITES AND WHISPERS FROM AROUND THE REGION

Take 5

WITH LOUISE MICHAEL
EMAIL: louise@plainsproducer.com.au

All will be unveiled at Shannon

SHANNON

INSTIGATED by Dublin Community Projects, an historical plaque providing the history of the former Shannon Methodist Church and cemetery will be unveiled on Sunday, September 15.

The unveiling will be done by Beryl Wilson (nee Rowe) who was married in the church and Chris Jenkin, a volunteer who has family connections to the cemetery.

The church was opened back in 1873 in the Hundred of Dublin, with various additions made over the years.

In 1957, the church closed due to dwindling numbers and in 1966, fearing the church would be vandalised, the trustees agreed to have it demolished!

A cairn was built at the church site in 1977 and a time capsule inserted.

Local Allan Parker planted some native trees on the church grounds in 1979, and will also be one of four people to plant a new tree at next month's dedication.

Others to plant a tree will be APC mayor Mark Wasley, Rev Dr Phil and Fraser Ellis.

In September 2018, a cemetery plot map board was initiated by Dublin Community Projects and installed by Adelaide Plains Council.

Im Telfer will be MC at the dedication service, and Rev Dr Phil Marshall will lead the dedication.

The Parham Singers will also be singing a hymn during the dedication service.

Delicious afternoon tea will then be provided by Long Plains Red Cross.

RSVP for catering is required by September 7 to Pat Thompson on 8529 2028.

CORNY CORNER

* Did anybody see the movie about the hotdog. It was an Oscar wiener



ABOVE: Jean Rowe, second daughter of Mr & Mrs WD Rowe of Calomba marrying Private Kenneth McCallum at Shannon Methodist Church on May 5, 1945. They are Margaret March of Balaklava's parents. RIGHT: The former Shannon Methodist church in 1898.



SALA

• Balaklava: The Courthouse Gallery is again involved in the SALA festival with the Balco Art Prize exhibition still on show until Sunday, September 1 – Father's Day!

Go and check out the wonderful art works on display (which are for sale) and perhaps pick up a SALA program and visit some of the other small galleries around.

The gallery is open Thursday, Fridays and Sunday from 2-4pm, and entry is free.

• Riverton: Light Gallery is also open for the SALA festival, and is having a special performance this Sunday at 1pm.

The Vocali Chamber Choral Acapella 'Vocali' will perform, and then you can enjoy a talk and display of works by artists Robert Hannaford and Alison Mitchell.

The inaugural recipient of the AME Bale Award (1969), Robert Hannaford asked homeless man Hans Krefel to sit for him, and this exhibition documents that extraordinary process.

Alison's array of small paintings of quiet times will allow you to reflect on life.

Their exhibition is open every weekend in August.

Hands up if you went to primary school 'back in th If so, do you have any information or stories yo share with the current ownr property, which is now a h I'm guessing Ro Woo

FAME OF



say
(mi
Lin
peo
Frid

Dear Diary: I tried running today. I am as swift as a gazelle. An old one... With Arthritis... R

Item/s copied on 15 September 2019
at the Unveiling of the Historical Plaque for the Shannon Methodist Church and Cemetery

Dublin Community Projects

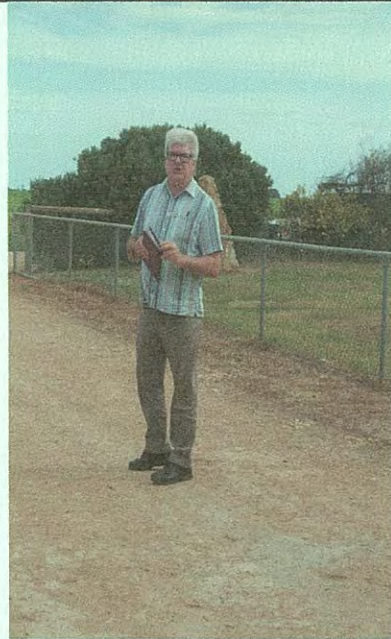
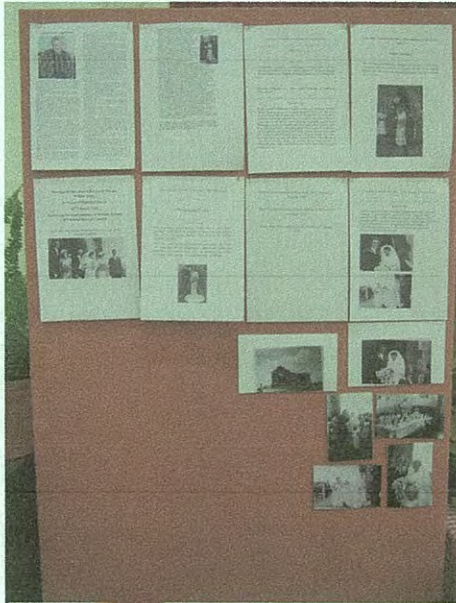



MONIES DONATED BY DUBLIN COMMUNITY PROJECTS

- 2013** Contribution towards DHG WW1 Memorial Tree project --remaining monies from
The New Dublin Cemetery fence and gate restoration project
- 2014** Purchase of a bench seat at Dublin Cemetery
Purchase of glass display cabinets for the Dublin History Group
Contribution towards the Memorial garden at the Dublin Institute
Assist with funding of blinds for the Dublin Institute
Restoration of Dublin Institute coach lights
- 2015** Purchase of WW1 soldiers dossiers and stationery for the Dublin History Group
Purchase of pie warmer for the Dublin Cricket Club
Contribution towards stove for the Thompson Beach Progress Ass. Club rooms
- 2016** Restoration of framed items for the Dublin History Group
- 2017** Contribution towards the purchase and installation of an for air conditioner for the
Dublin Institute
Purchase of a bench seat at Dublin Cemetery
Purchase of an honour board for the Dublin History Group
Replacement of stolen Lions Park time capsule plaque in Dublin
Purchase of document storage items for the Dublin History Group
Purchase of membership medallions for the Port Parham Littlies Theatrical Group
Donation to the Avon Art and Craft Group
- 2018** Purchase and installation of blinds in the Windsor Institute
Donation to the Dublin CFS extension appeal
Purchase of photographic paper and ink for the Dublin History Group Institutes project
Purchase of storage containers for the Dublin History Group
Purchase of a fridge for the Thompson Beach Progress Association
Transfer of videos to cd for the Dublin History Group
Installation of Plot Map Boards for both Shannon (Long Plains) and Dublin Cemeteries
- 2019** Installation and unveiling of an historical plaque by Mrs Beryl Wilson and Mr Mark
Wasley, Mayor, Adelaide Plains Council on 15 9 2019 giving the history together with a
photograph of the church, for both the former Shannon Methodist Church and the
Shannon Cemetery,

To date since 2013 in total of \$14, 933-27 has been raised and donated

Nomination Form:



Adelaide
Plains
Council

Nominee (the person/organisation you would like to nominate)

Please provide as much information as possible. Additional documents may be attached providing further information or testimonials of achievement.

Award Category (please tick)

- CITIZEN YOUNG CITIZEN COMMUNITY EVENT
 COMMUNITY PROJECT COMMUNITY GROUP

Name: PARHAM AND DISTRICT ACTION GROUP

Address: [REDACTED]

Phone: [REDACTED]

Date of Birth:

Email: [REDACTED]

Is the person being nominated an Australian citizen? YES NO

Reason for nomination

How has the person/organisation contributed to the community?

Managed and completed a foreshore enhancement program at Port Parham including provision of fencing to prevent vehicles entering sensitive areas, provision of sand ladders for pedestrian access over sandhills and planting of over 500 seedlings of native plants. Fencing at the

Please list any other significant contributions and/or achievements:

Parham Campground was also upgraded or replaced. Total project cost was \$33,000 of which \$10,700 was provided by a sustainability grant from Conservation SA. 450 volunteer hours were expended on the project.

Additional material may be attached: maximum five A4 pages, minimum font size 10 point.

Nominator (your details)

Name: [REDACTED]

Address: [REDACTED]

Phone: [REDACTED]

Email: [REDACTED]

I give permission for the Australia Day Council of South Australia to submit this nomination for recognition programs such as the Australian of the Year Awards.

Please return completed form before Friday 15 November 2019 to:

Anne Sawtell, Library and Community Services Manager, Adelaide Plains Council, PO Box 18, MALLALA SA 5502
Or email info@apc.sa.gov.au

For further information please contact the Manager Library and Community Services on 8527 0200.

Nomination Form:



**Adelaide
Plains
Council**

Nominee (the person/organisation you would like to nominate)

Please provide as much information as possible. Additional documents may be attached providing further information or testimonials of achievement.

Award Category (please tick)

- CITIZEN
- YOUNG CITIZEN
- COMMUNITY EVENT
- COMMUNITY PROJECT
- COMMUNITY GROUP

Name: PINERY FIRE MEMORIAL AND HISTORY OF GIPPS PLAINS

Address: [REDACTED]

Phone: [REDACTED] Date of Birth: N/A

Email: [REDACTED]

Is the person being nominated an Australian citizen? YES NO

Reason for nomination

How has the person/organisation contributed to the community?

REFER TO ATTACHED

Please list any other significant contributions and/or achievements:

REFER TO ATTACHED

Additional material may be attached: maximum five A4 pages, minimum font size 10 point.

Nominator (your details)

Name: [REDACTED]

Address: [REDACTED]

Phone: [REDACTED]

Email: [REDACTED]

I give permission for the Australia Day Council of South Australia to submit this nomination to other recognition programs such as the Australian of the Year Awards.

Please return completed form before Friday 15 November 2019 to:

Anne Sawtell, Library and Community Services Manager, Adelaide Plains Council, PO Box 18, MALLALA SA 5502

Or email info@apc.sa.gov.au

For further information please contact the Manager Library and Community Services on 8527 0200.

NOMINATION FOR AUSTRALIA DAY AWARDS - 2020

COMMUNITY PROJECT

'GRACE PLAINS HISTORY AND PINERY FIRE MEMORIAL, MOQUET LEE RESERVE, GRACE PLAINS'

HOW HAS THE PROJECT CONTRIBUTED TO THE COMMUNITY?

This Project has been an extensive process of research, consultation and volunteer assistance in an effort to produce a permanent memorial.

This memorial will include:

- a memorial to recognise and remember the impact, lives lost and devastation of the *Pinery Fires*
- an historical reference point for the *Moquet Lee Reserve and memorial* for Private William Fred Nairn
- a history of *Grace Plains*; sport and recreation, church and primary school
- a refurbishment of the *Grace Plains cemetery fences and gates* and

This was a challenging multi-faceted Project, with numerous milestones and desired outcomes. It took the enormous input of the local community, volunteers, Lions Club of Mallala, local Council and businesses, combined with fund raising and donations to bring this Project to fruition.

The intent of the Project was to utilize the land at the rear of the old Grace Plains Church and current cemetery that was gifted to the local community, as a central memorial and historic public space and to refurbish the Grace Plains cemetery fencing and incorporate a new entry gate in keeping with the importance of the total memorial area.

For a community to stay strong it needs to not only understand the present but also to understand its past and the sacrifices made for their community and for the nation.

DISPLAYS AND MEMORIALS



Private William Fred Nairn

Memorial and dedication to Private William Fred Nairn (6th August 1892 – 21st September 1916) who fought in the The Battle of Mouquet Farm (23 July – 3 September 1916) was part of the Battle of the Somme and began during the Battle of Pozières.

Born: Mallala, 4th August 1897

Died: 21st September, 1916 – Aged 19 years

Moquet Lee Reserve- Sport and Recreation

The Moquet Lee Reserve had always been used for recreation. The 2 hectares included an oval, tennis courts, a croquet green and associated pavilion that was surrounded by pine and gum trees. Grace Plains boasted one of the earlier football teams with a premiership win in 1926.

This Project will include a pictorial history of some of the sporting achievements of the area.



Grace Plains Historic Church and Primary School

Forming part of the larger display will be historic images and information reflecting extensive research into the history of the Church and local primary school.

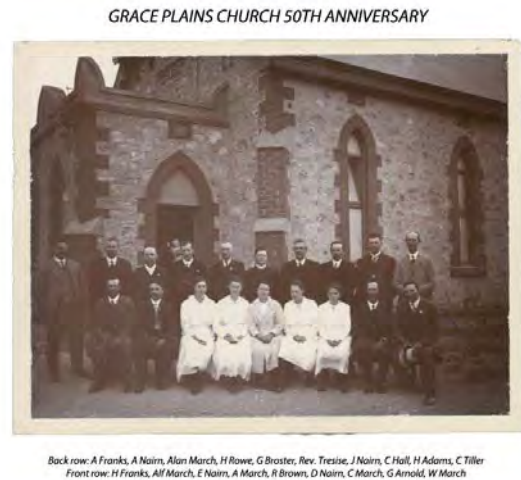

Pinery Fire

On November 25th, 2015 the Adelaide Plains area was devastated by the uncontrollable inferno which took the lives of two of our residents, destroyed 97 homes, 546 farm structures, 413 pieces of farm equipment, 74,000 head of livestock & poultry, \$30 million worth of unreact crops, and burnt an area of 85,000 Ha, which is larger than the area of greater Adelaide; all of this in about 5 hours.

This Project aimed to show the timeline, impact and recovery in both pictorial and information displays and also to remember those who lost their lives during the devastating fire. The displays are 1.2m and form part of a total 25m² of reading material.

Grace Plains Cemetery Fence and Gates

To ensure that the total experience is respectful, the cemetery fences were replaced and new entry gates made by local volunteers.

The area was damaged during the fire and as such refurbishment of the entire area was required.

OVERVIEW

During the Pinery fire the trees and infrastructure of the area sustained significant damage. The small community saw an opportunity to rebuild and make a more suitable memorial that will be easier to maintain by local volunteers.

It is also important to recognise that the memorial pays tribute to the life of Fred Nairn and the history of the Grace Plains district.

There are over 270 historic photos and content remembering the fires and the original settlement of the district.

The displays will cover 21 metres X 1.2 metres which is about 25 square metres of reading material.

This Project aimed to ensure there will be a place that people could visit, and gain knowledge of local history.

It is hoped that this display will be accessed by tourists, local communities and form part of potential learning outcomes for school groups.

Please note: a comprehensive list of both business and community involvement can be obtained direct from Mr Peter March, Chairperson, Moquet Lee Trustees should this be required in determining the extent of community contributions and importance.

NOMINATION FOR AUSTRALIA DAY AWARDS - 2020
COMMUNITY PROJECT – UPDATED INFORMATION

***'GRACE PLAINS HISTORY AND PINERY FIRE MEMORIAL,
MOQUET LEE RESERVE, GRACE PLAINS'***

HOW HAS THE PROJECT CONTRIBUTED TO THE COMMUNITY?

This Project has been an extensive process of research, consultation and volunteer assistance in an effort to produce a permanent memorial.

This was a challenging multi-faceted Project, with numerous milestones and desired outcomes. It took the enormous input of the local community, volunteers, Lions Club of Mallala, local Council and businesses, combined with fund raising and donations to bring this Project to fruition.

The intent of the Project was to utilize the land at the rear of the old Grace Plains Church and current cemetery that was gifted to the local community, as a central memorial and historic public space and to refurbish the Grace Plains cemetery fencing and incorporate a new entry gate in keeping with the importance of the total memorial area. The area is known as the Moquet Lee Reserve.

For a community to stay strong it needs to not only understand the present but also to understand its past and the sacrifices made for their community and for the nation.

YOU CAN NOT HAVE A BRIGHT FUTURE WITHOUT THE ILLUMINATION OF THE PAST

THE PROJECT OVERVIEW

During the Pinery fire the trees and infrastructure of the area sustained significant damage. The small community saw an opportunity to rebuild and make a more suitable memorial that will be easier to maintain by local volunteers.

The site has 7 different aspects to it:

➤ **The Pinery Fire Memorial as the focal point.**

On November 25th, 2015 the Adelaide Plains area was devastated by the uncontrollable inferno which took the lives of two of our residents, destroyed 97 homes, 546 farm structures, 413 pieces of farm equipment, 74,000 head of livestock & poultry, \$30 million worth of unreact crops, and burnt an area of 85,000 Ha, which is larger than the area of greater Adelaide; all of this in about 5 hours.

This Project aimed to show the timeline, impact and recovery in both pictorial and information displays and also to remember those who lost their lives during the devastating fire. The displays are 1.2m and form part of a total 25m² of reading material.



➤ **The tribute to Fred Nairn from which the Moquet Lee name is derived.**



- Private William Fred Nairn
- Memorial and dedication to Private William Fred Nairn (6th August 1892 – 21st September 1916) who fought in the The Battle of Mouquet Farm (23 July – 3 September 1916) was part of the Battle of the Somme and began during the Battle of Pozières.
- Born: Mallala, 4th August 1897
- Died: 21st September, 1916 – Aged 19 years

- **The hard work of the Grace Plains community since the fire 4 years ago has been recognised in the "Pavilion" with pictorial and written display, and has a board recognising the financial contributors. A display featuring the events of opening day have been added since the event.**

Brenton Darby explains how to use the provided equipment to Trish Springbett



- **150 years of the history of Grace Plains is also on display and will be of interest to many people**

Forming part of the larger display will be historic images and information reflecting extensive research into the history of the Church and local primary school.

GRACE PLAINS SCHOOL - 1947



Back Row: Max Davies, Lois Broster, Gwenda Secomb, Ruth March
Middle Row: Eric Secomb, Leon Broster, Lawrie Dunlop, Vera March, Elizabeth Franks
Front Row: John Franks, Rosemary Dunlop, Peter March

GRACE PLAINS CHURCH 50TH ANNIVERSARY



Back row: A Franks, A Nairn, Alan March, H Rowe, G Broster, Rev. Tresise, J Nairn, C Hall, H Adams, C Tiller
Front row: H Franks, Alf March, E Nairn, A March, R Brown, D Nairn, C March, G Arnold, W March

- **The donated 216,000 litre fire fighting tank installed at the rear is a part of the planning to help protect our community if an event similar to the Pinery fire occurs in future. This tank is equipped to handle CFS trucks and farm fire fighting vehicles at separate points.**



- **The cemetery which was substantially damaged in the fire, and partially buried with the subsequent 6 months of sand drifting into it from the bare paddocks has been cleaned and re fenced in co operation with the Adelaide Plains Council with a structure which replicates the original fence around the former Grace Plains Church which is adjacent to the site.**
Council supplied the material and we erected the fence with our own voluntary labour. New entrance gates and an arch have been designed, erected and paid for by our residents, and we also organised for

the whole area to be coated with a layer of gravel. We also arranged for all of the headstones to be professionally cleaned. This has resulted in a total transformation and resulted in many favourable comments on the day.



- **The 7th aspect was completed as a result of the Federal Drought Fund Grant which allowed us to provide a neat clean surface on what were the old tennis courts, and to lay a bitumen surround at the fire fighting tank so that CFS and farm units are not working under unsafe and muddy conditions**



The memorial is open and free to the public all day, every day and we encourage anyone including schools, community groups, tourists and the general public to drop in at any time.



Local residents discuss the initial planning for the clearing and redevelopment of the site.



The current site showing the new cemetery gates and fencing; site fencing; new under cover pavilion and display area and newly coated parking area for tourist, local community members and for better access to the cemetery

Citizen of the Year 2020

The following table is a guide to assist you with the final selection for Citizen of the Year. Further information is listed on the nomination form.

No.	Nominated Person	Contribution to the community					Scope of impact on the local government area					Inspirational Role Model					Overall rating and Comments
		1	2	3	4	5	1	2	3	4	5	1	2	3	4	5	
1	Craig Argent	1	2	3	4	5	1	2	3	4	5	1	2	3	4	5	How has the person(s) contributed to the Community? <i>please refer nomination form for additional information</i> Strong community involvement with Vanuatan residents in town - opening Post Office after hours to accommodate them. Driving member for Mallala Christmas Street Parade. Other significant achievements Mallala Football Club - Committee member for over 25 years. Been active community member for over 30 years. Mallala Bowling Club - running Night Owls Competition.
		<input type="checkbox"/>	<input type="checkbox"/>	<input type="checkbox"/>	<input type="checkbox"/>	<input type="checkbox"/>	<input type="checkbox"/>	<input type="checkbox"/>	<input type="checkbox"/>	<input type="checkbox"/>	<input type="checkbox"/>	<input type="checkbox"/>	<input type="checkbox"/>	<input type="checkbox"/>	<input type="checkbox"/>	<input type="checkbox"/>	
2	Rae Corston	1	2	3	4	5	1	2	3	4	5	1	2	3	4	5	How has the person(s) contributed to the Community? <i>please refer nomination form for additional information</i> Involved with TW community for over 37 years - including 6 years in various capacities at TW Primary School. Drove school bus in Two Wells & Lewiston areas for over 20 years in voluntary capacity. Other significant achievements Founding member of TW Softball Club, TW Hockey Club and TW District Family History Group.
		<input type="checkbox"/>	<input type="checkbox"/>	<input type="checkbox"/>	<input type="checkbox"/>	<input type="checkbox"/>	<input type="checkbox"/>	<input type="checkbox"/>	<input type="checkbox"/>	<input type="checkbox"/>	<input type="checkbox"/>	<input type="checkbox"/>	<input type="checkbox"/>	<input type="checkbox"/>	<input type="checkbox"/>	<input type="checkbox"/>	
3	Pat Thompson	1	2	3	4	5	1	2	3	4	5	1	2	3	4	5	How has the person(s) contributed to the Community? <i>please refer nomination form for additional information</i> Extraordinary efforts to the Dublin community through various projects including Dublin Ward cemeteries. Organised Rose Garden & Garden Expose, & the War Memorial adjacent to gardens. Long involvement with Dublin History Group & Dublin Dispatch. Other significant achievements Tree planting for WW1 Soldiers at Dublin Institute, Shannon Cemetery Historical Plaque. Hours of local history research and money-raising efforts.
		<input type="checkbox"/>	<input type="checkbox"/>	<input type="checkbox"/>	<input type="checkbox"/>	<input type="checkbox"/>	<input type="checkbox"/>	<input type="checkbox"/>	<input type="checkbox"/>	<input type="checkbox"/>	<input type="checkbox"/>	<input type="checkbox"/>	<input type="checkbox"/>	<input type="checkbox"/>	<input type="checkbox"/>	<input type="checkbox"/>	
AWARDS IN CONFIDENCE															How has the person(s) contributed to the Community? of 1		

Australia Day
**Citizen of the
 year Awards**

**Community Event
 2020**

The following table is a guide to assist you with the final selection for Community Event of the Year. Further information is listed on the nomination form.

No.	Nominated Community Event	Contribution to the community	Scope of impact on the local government area	Inspiration to Community	Overall rating and Comments
1	Pinery Fire Memorial Grand Opening 24/11/2019	1 2 3 4 5 <input type="checkbox"/> <input type="checkbox"/> <input type="checkbox"/> <input checked="" type="checkbox"/> <input type="checkbox"/>	1 2 3 4 5 <input type="checkbox"/> <input type="checkbox"/> <input type="checkbox"/> <input type="checkbox"/> <input type="checkbox"/>	1 2 3 4 5 <input type="checkbox"/> <input type="checkbox"/> <input type="checkbox"/> <input type="checkbox"/> <input type="checkbox"/>	<p>How has the person(s) contributed to the Community? <i>please refer nomination form for additional information</i> Victims & communities impacted by Pinery Fire have worked together to develop a commemorative memorial in recognition of 4th year anniversary of Pinery Fires.</p> <p>Other significant achievements Launch recognises and remembers the impact, lives lost & devastation of the Pinery Fire. Launch was held on the eve of the Pinery Fire - 24 November 2019.</p>
				Total	14

Australia Day
**Citizen of the
 year Awards**

Community Project of the Year 2020

The following table is a guide to assist you with the final selection for the Community Project of the Year. Further information is listed on the nomination form.

No.	Nominated Community Project	Contribution to the community	Scope of impact on the local government area	Inspiration to Community	Overall rating and Comments
1	Pinery Fire Memorial & History of Grace Plains	1 2 3 4 5 <input type="checkbox"/> <input type="checkbox"/> <input type="checkbox"/> <input checked="" type="checkbox"/> <input type="checkbox"/>	1 2 3 4 5 <input type="checkbox"/> <input type="checkbox"/> <input type="checkbox"/> <input type="checkbox"/> <input type="checkbox"/>	1 2 3 4 5 <input type="checkbox"/> <input type="checkbox"/> <input type="checkbox"/> <input type="checkbox"/> <input type="checkbox"/>	How has the person(s) contributed to the Community? <i>please refer nomination form for additional information</i> Utilized land at rear of old Church and current cemetery which was gifted to the community, as a central memorial & historic public space and refurbished Cemetery fencing. Numerous memorials eg Private William Nairn. Moquet Lee Reserve including pictorial history - sporting achievements. Multi faceted Project - enormous input from community, volunteers, Mallala Lions Club, Council and businesses. Other significant achievements Grace Plains Historic Church and Primary School - part of a larger display - with images of Church and Primary School. Display to be accessed by tourists, local community & schools. (also see Community Event of the Year - sole nomination)
				Total 14	
2	Parham & District Action Group	1 2 3 4 5 <input type="checkbox"/> <input type="checkbox"/> <input type="checkbox"/> <input checked="" type="checkbox"/> <input type="checkbox"/>	1 2 3 4 5 <input type="checkbox"/> <input type="checkbox"/> <input type="checkbox"/> <input checked="" type="checkbox"/> <input type="checkbox"/>	1 2 3 4 5 <input type="checkbox"/> <input type="checkbox"/> <input type="checkbox"/> <input checked="" type="checkbox"/> <input type="checkbox"/>	How has the person(s) contributed to the Community? <i>please refer nomination form for additional information</i> Managed and completed foreshore enhancement project at Parham, including provision of fencing to prevent vehicles entering. Over 500 seedlings planted via pedestrian access. Other significant achievements Upgraded Parham Campground - 450 volunteer hours committed to this project (also see Community Group nom'n).
				Total 12	
					How has the person(s) contributed to the Community?

3	Dublin Community Projects	1	2	3	4	5	1	2	3	4	5	1	2	3	4	5	<p><i>please refer nomination form for additional information</i></p> <p>Planning and dedication of the former Shannon Methodist Church & Cemetery Historical Plaque - took place on 15/9/19 - took several years to plan, including raising funds. Memorial for the demolished Church.</p> <p>Other significant achievements</p> <p>Local Dublin businesses together with Pt Parham Sports & Social Club & Dublin Committee Projects - team effort. (also see Community Group nomination)</p>
		<input type="checkbox"/>	<input type="checkbox"/>	<input type="checkbox"/>	<input type="checkbox"/>	<input type="checkbox"/>	<input type="checkbox"/>	<input type="checkbox"/>	<input type="checkbox"/>	<input type="checkbox"/>	<input type="checkbox"/>	<input type="checkbox"/>	<input type="checkbox"/>	<input type="checkbox"/>	<input type="checkbox"/>	<input type="checkbox"/>	

Australia Day
**Citizen of the
 year Awards**

Community Group of the Year 2020

The following table is a guide to assist you with the final selection for Community Group of the Year. Further information is listed on the nomination form.

No.	Nominated Community Group	Contribution to the community	Scope of impact on the local government area	Inspiration to Community	Overall rating and Comments
1	Two Wells Melodrama Group	1 2 3 4 5 <input type="checkbox"/> <input type="checkbox"/> <input type="checkbox"/> <input checked="" type="checkbox"/> <input type="checkbox"/>	1 2 3 4 5 <input type="checkbox"/> <input type="checkbox"/> <input type="checkbox"/> <input checked="" type="checkbox"/> <input type="checkbox"/>	1 2 3 4 5 <input type="checkbox"/> <input type="checkbox"/> <input type="checkbox"/> <input checked="" type="checkbox"/> <input type="checkbox"/>	How has the person(s) contributed to the Community? please refer nomination form for additional information Founded in 1982, raised more than \$700,000 through its annual amateur theatre productions. Funds have been 'put back' into the local community eg TW Wells Community Centre. Other significant achievements For nearly 40 years TW MG has supporting local community & sporting groups, as well as providing a creative outlet for those involved in the theatrical productions. Total 12
2	Parham & District Action Group	1 2 3 4 5 <input type="checkbox"/> <input type="checkbox"/> <input type="checkbox"/> <input checked="" type="checkbox"/> <input type="checkbox"/>	1 2 3 4 5 <input type="checkbox"/> <input type="checkbox"/> <input type="checkbox"/> <input checked="" type="checkbox"/> <input type="checkbox"/>	1 2 3 4 5 <input type="checkbox"/> <input type="checkbox"/> <input type="checkbox"/> <input checked="" type="checkbox"/> <input type="checkbox"/>	How has the person(s) contributed to the Community? please refer nomination form for additional information Applying and utilising a grant for Foreshore enhancement & developed a Community Development Plan for Parham & Webb Beach. Other significant achievements Promoting local issues with Council. Facilitating discussion within the community on community development projects. (refer to comments - Community Project of the Year) Total 12
3	Dublin Community Projects	1 2 3 4 5 <input type="checkbox"/> <input type="checkbox"/> <input type="checkbox"/> <input checked="" type="checkbox"/> <input type="checkbox"/>	1 2 3 4 5 <input type="checkbox"/> <input type="checkbox"/> <input checked="" type="checkbox"/> <input type="checkbox"/> <input type="checkbox"/>	1 2 3 4 5 <input type="checkbox"/> <input type="checkbox"/> <input type="checkbox"/> <input checked="" type="checkbox"/> <input type="checkbox"/>	How has the person(s) contributed to the Community? please refer nomination form for additional information Supports community groups within the Dublin area including the planning and dedication of the former Shannon Methodist Church & Cemetery Historical Plaque - 15 September 2019. Other significant achievements (refer to comments - Community Project of the Year.) Total 11 please refer nomination form for additional information Established in 2017 - small group of local children aged 7

4	Adelaide Plains Drama Group	1	2	3	4	5	1	2	3	4	5	1	2	3	4	5	to 12 years who meet weekly during school term. Have 11 active members - mainly from Mallala & a few from Balaklava. Alternative group for non-sporting children to be involved. Other significant achievements Have competed in Balaklava Eisteddfod and Now Talent - have been successful.
		<input type="checkbox"/>	<input type="checkbox"/>	<input type="checkbox"/>	<input type="checkbox"/>	<input type="checkbox"/>	<input type="checkbox"/>	<input type="checkbox"/>	<input type="checkbox"/>	<input type="checkbox"/>	<input type="checkbox"/>	<input type="checkbox"/>	<input type="checkbox"/>	<input type="checkbox"/>	<input type="checkbox"/>	<input type="checkbox"/>	